

GLUE 1/16 SQ OVER PLAN

ELEVATOR ASSEMBLED OVER PLAN

POSITION OF ELEVATOR

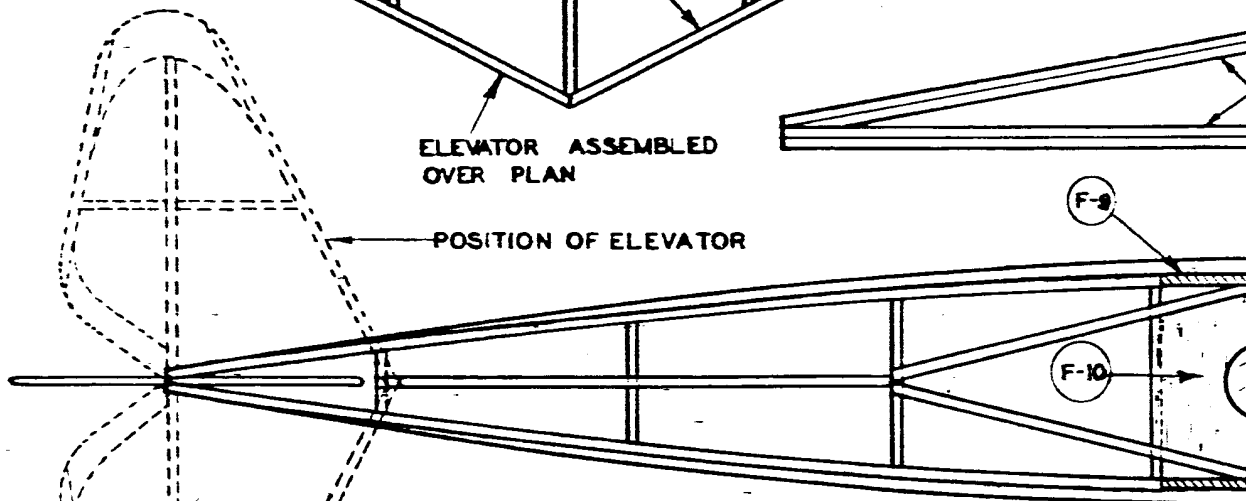

TOP VIEW

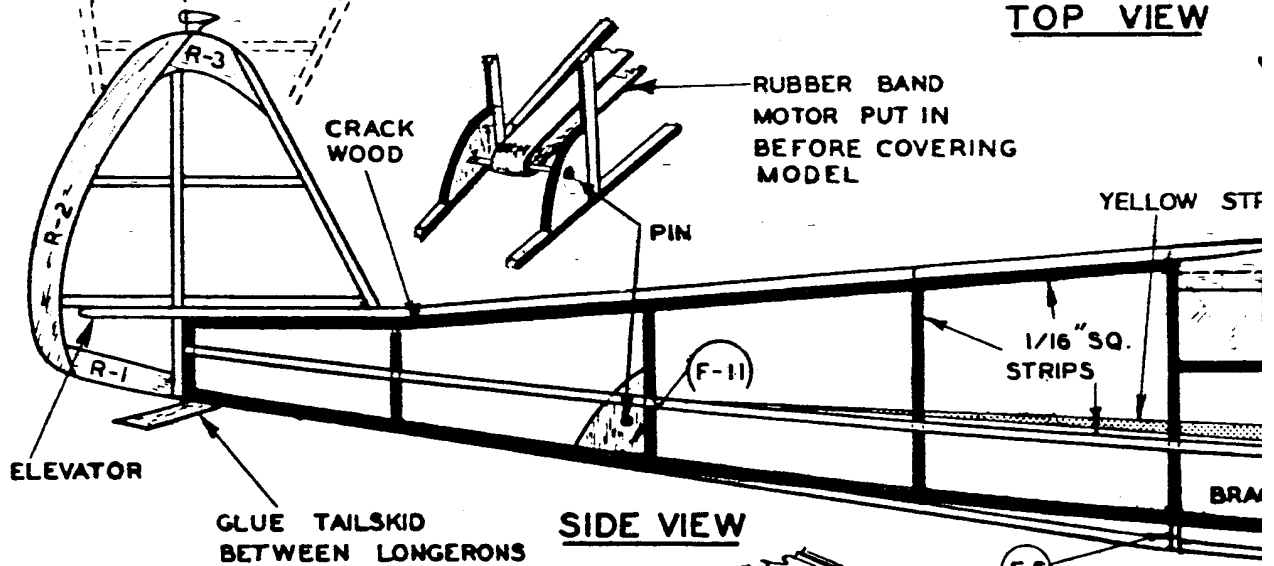

SIDE VIEW

(F-5)

GLUE STRUT HERE

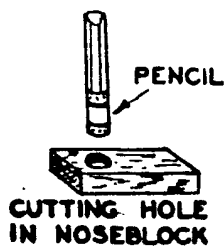

WING STRUT ATTACHMENT



GLUE LANDING GEAR FIRMLY TO LONGERON

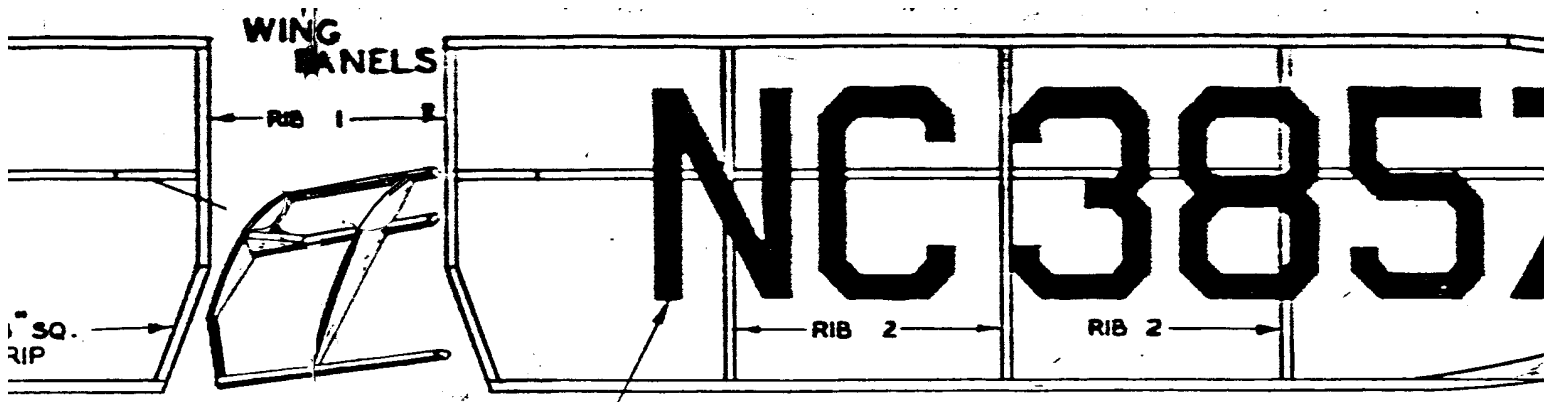

CUT OUT LICENSE NUMBERS

FRONT VIEW 1/2 SIZE

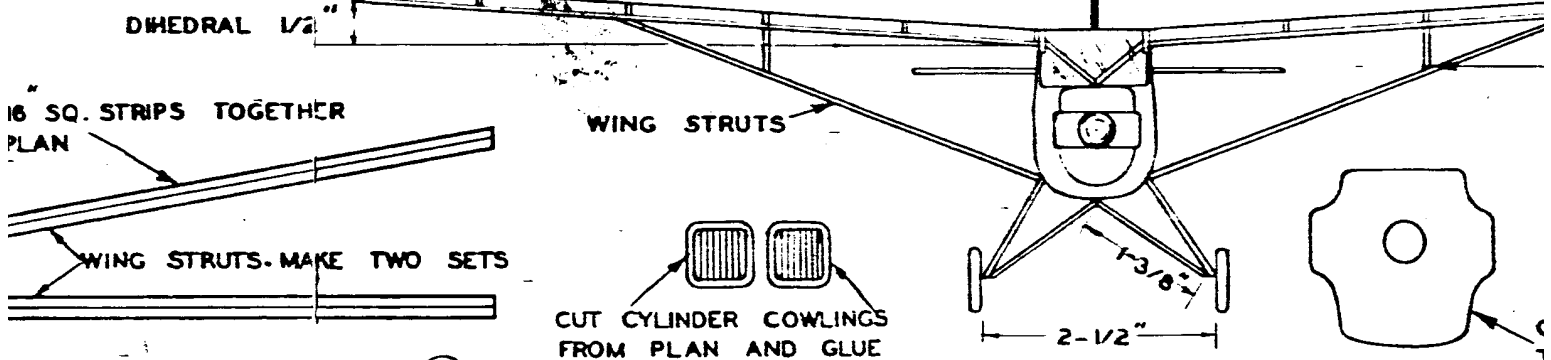

CUT CYLINDER COWLINGS FROM PLAN AND GLUE TO NOSE BLOCK

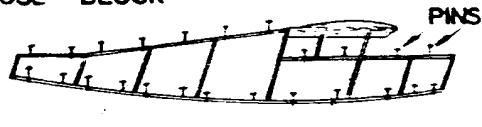
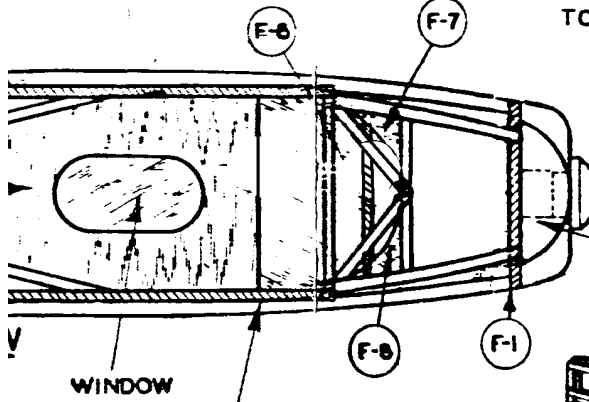

COLOR SCHEME -  
 BODY- DARK BLUE  
 WING, RUDDER &  
 ELEVATOR -YELLOW

FOR SHO

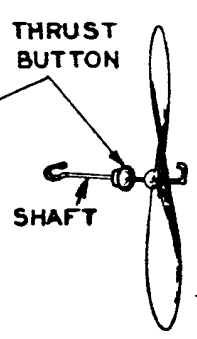
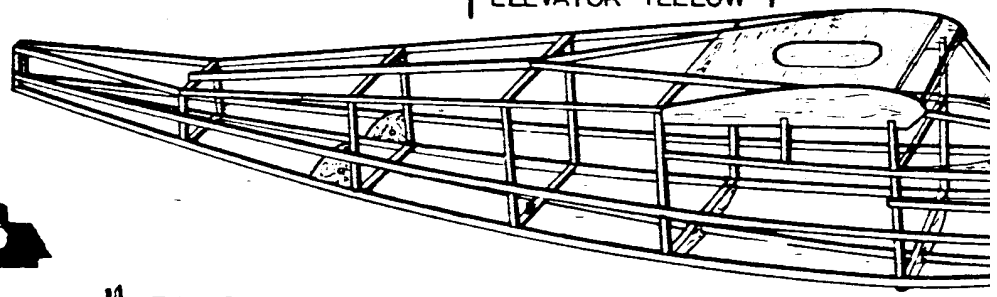
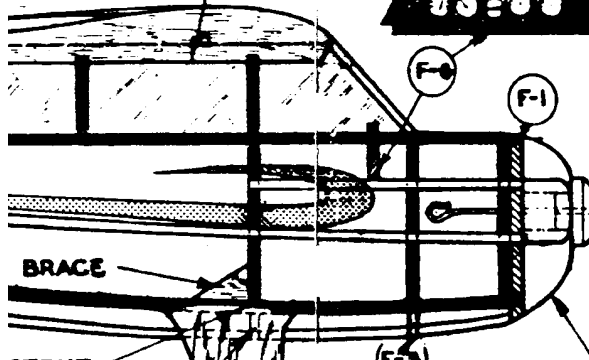
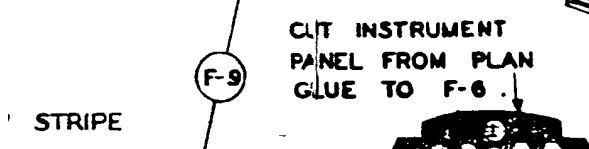

IF RUBBER MOTOR CANNOT BE OBTAINED FROM YOUR MODEL SUPPLY DEALER, USE RUBBER LOOP CUT FROM OLD INNER TUBE OR SEVERAL SMALLER BANDS JOINED.

IN FL TEND SMALL NOSE

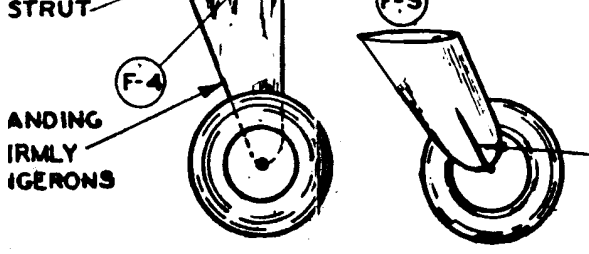

**LUSCOMBE**

WINGSPAN 16"

DRAWN BY *Sidney*

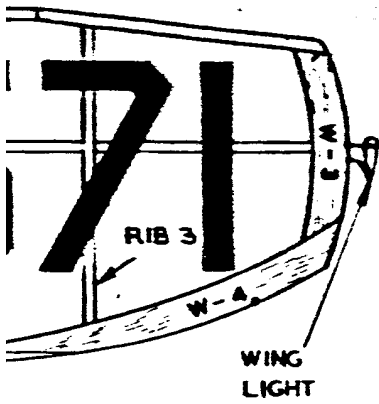

SIZE

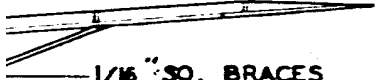

1/16" SQ. BRACES

FINISHED  
NOSE BLOCK



CUT NOSE BLOCK  
THIS SHAPE

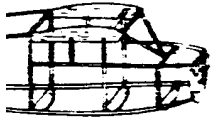

STEP

FORMER 6 NOT  
SHOWN

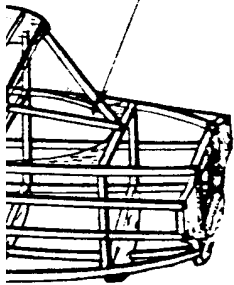

IN FLYING, IF MODEL  
TENDS TO STALL, ADD  
SMALL WEIGHTS TO THE  
NOSE.

MBE "50"

" LENGTH 10 "

Ray Abelrod | KIT NO. A2