

IMPORTANT NOTE
PLACE LEADING AND TRAILING EDGES OF WINGS ON PLAN AND HOLD IN CURVED POSITION WITH PINS. THEN GLUE SPAR, RIBS AND WING TIP IN PLACE. WHEN GLUE HAS DRIED, SOAP LEADING AND TRAILING EDGES WITH WATER AND ALLOW TO DRY. NEXT REMOVE WING UNIT FROM PLAN AND THE CURVE WILL STAY IN THE STRIPS.

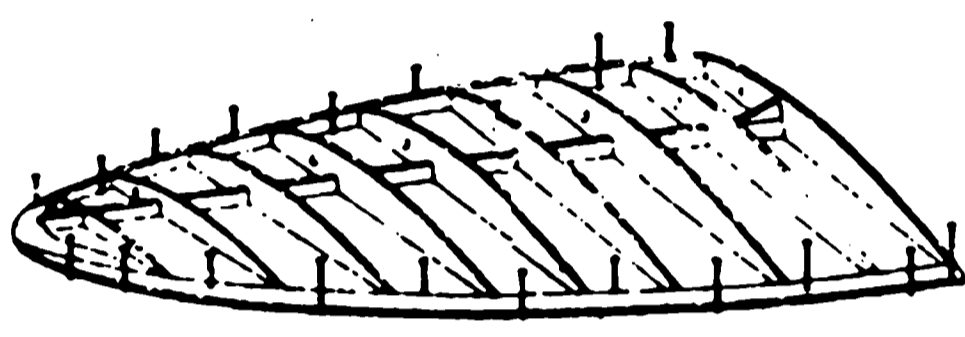

OPTIONAL NOSE CONSTRUCTION
CONSTRUCTION SHOWN IN THE TWO SKETCHES AT RIGHT PERMITS MORE OF THE MOTOR TO BE EXPOSED. THIS CAN BE USED INSTEAD OF THE TYPE SHOWN ON OTHER FUSELAGE VIEWS.

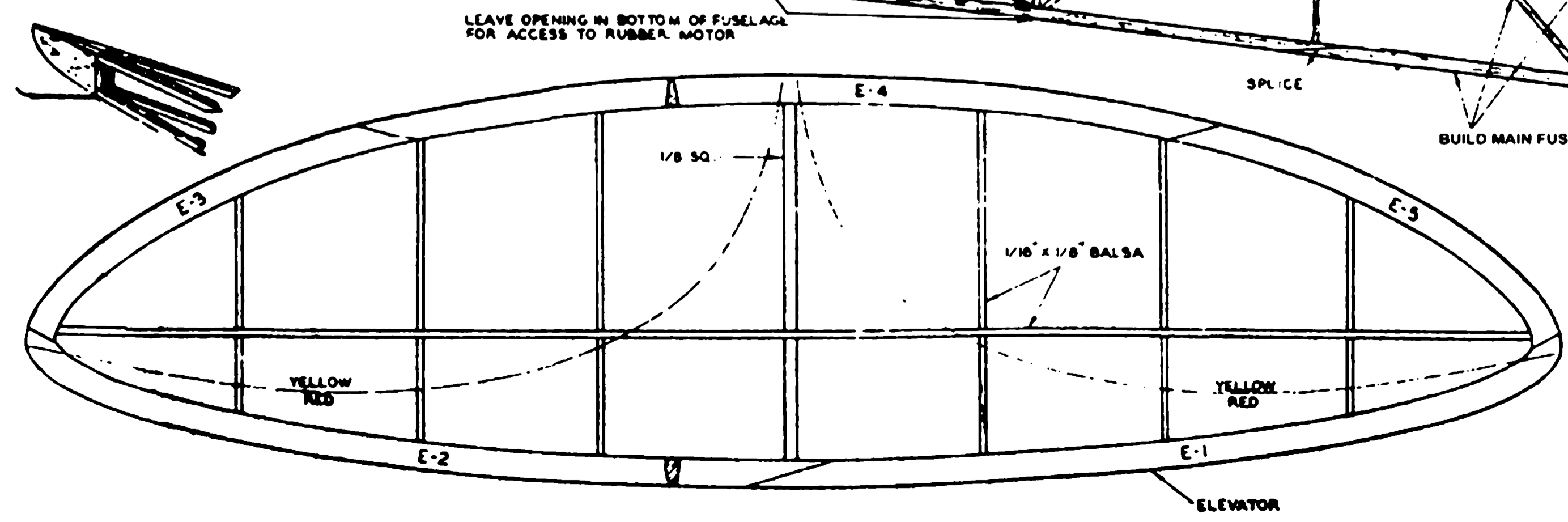
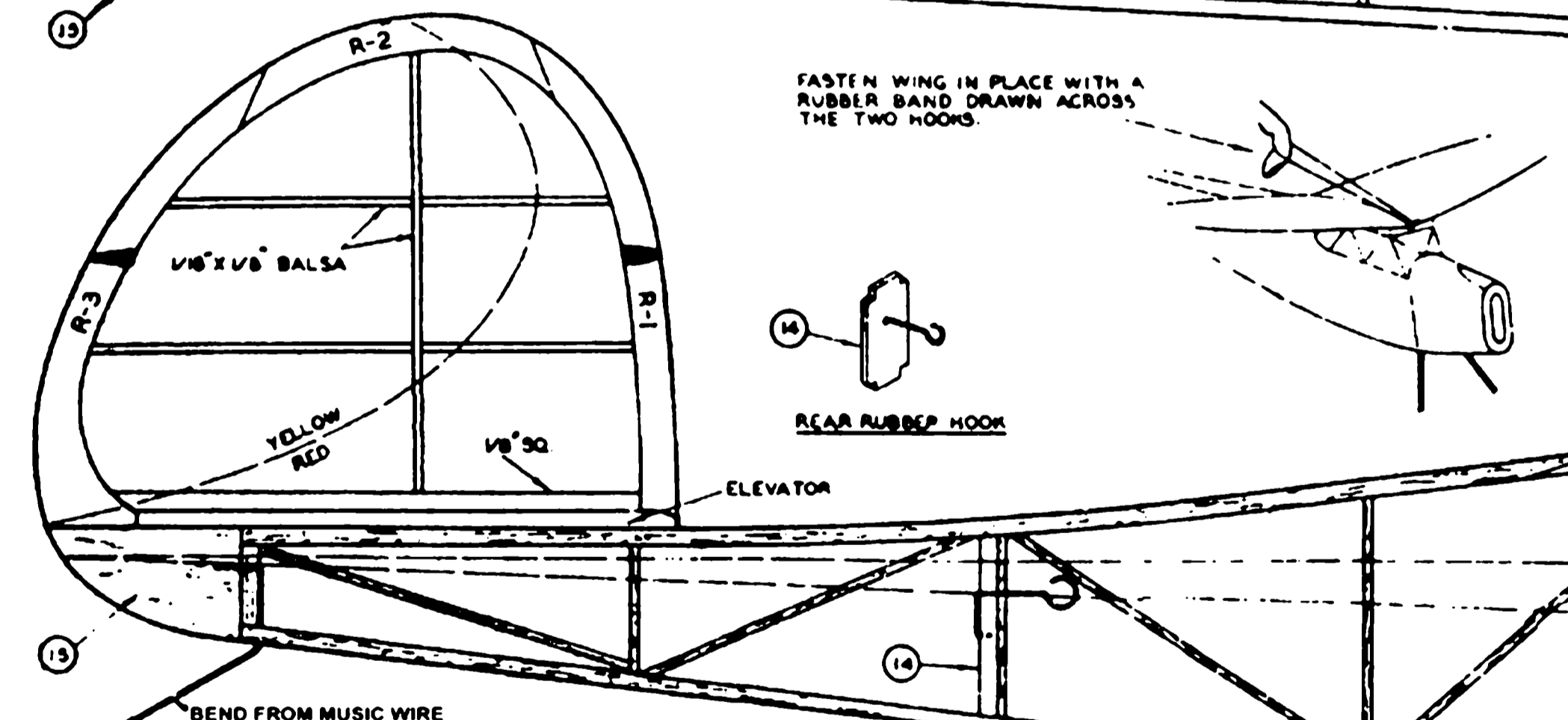
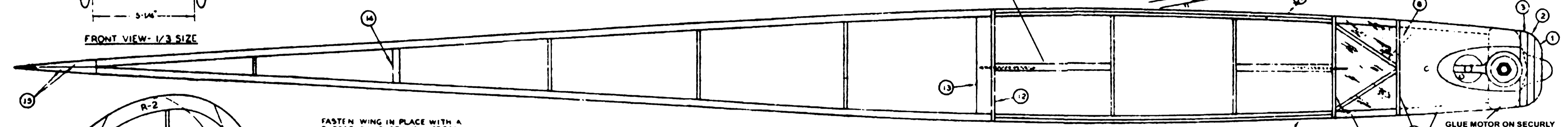
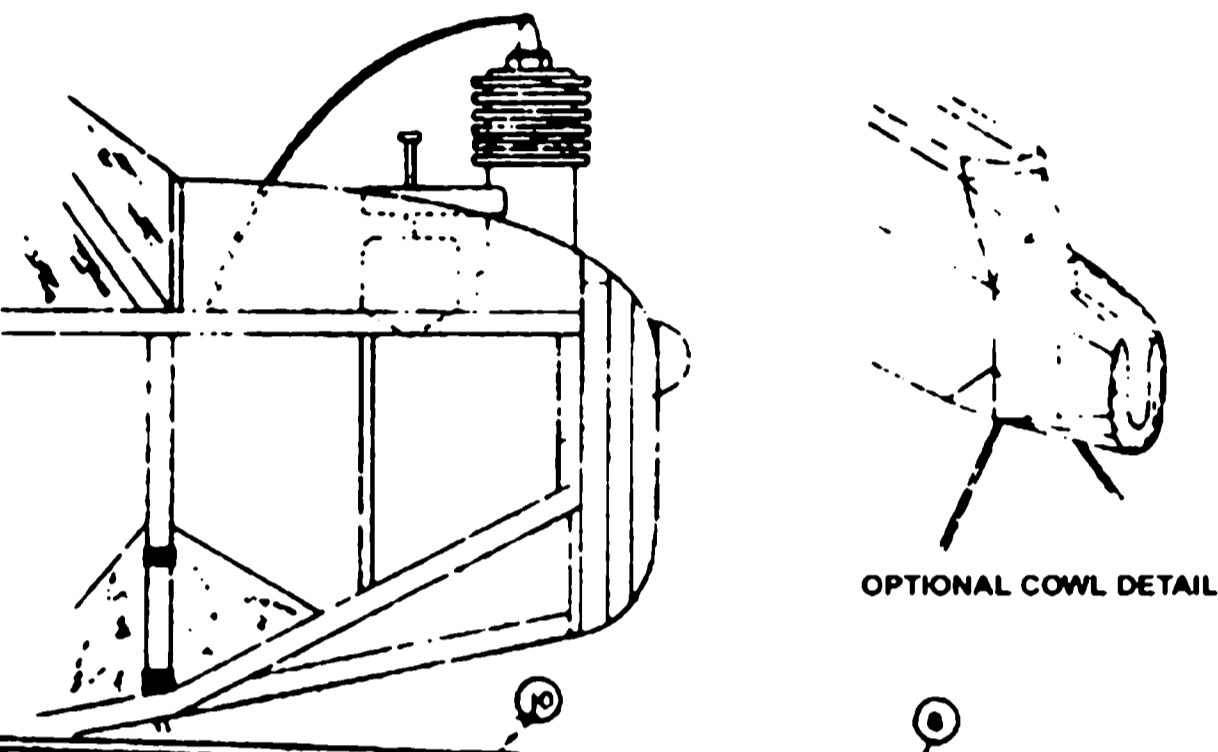

COLOR SCHEME
COVER ENTIRE MODEL EXCEPT TOP & BOTTOM OF FUSELAGE WITH YELLOW TISSUE. THEN CUT RED TISSUE TO SHAPE OF DESIGN AND STICK TO YELLOW TISSUE COVERING.

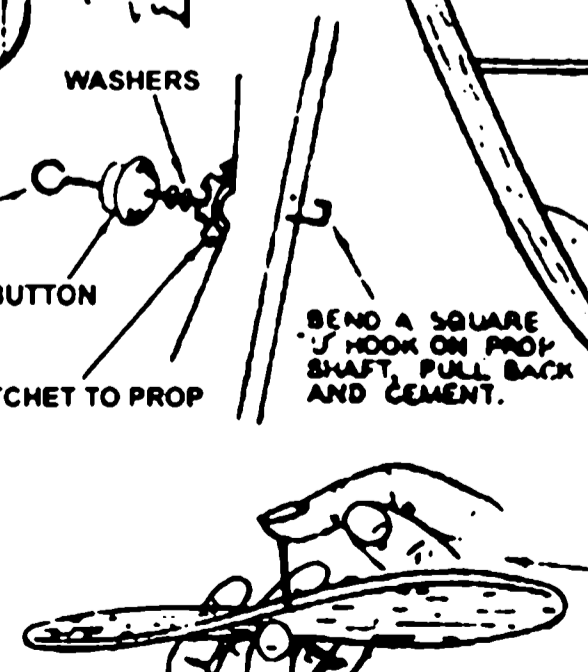
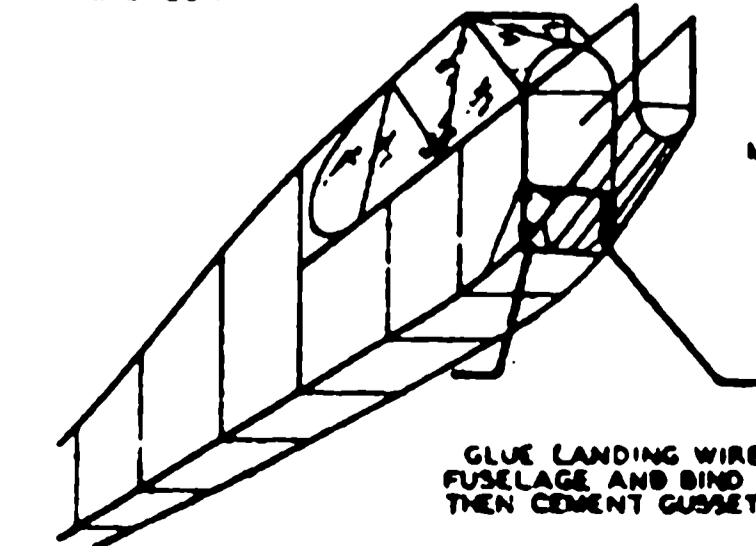

JUNIOR CLIPPER
WINGSPAN -36" LENGTH -27"
DRAWN BY *John* KIT NO. P5

