

OTT-O-FORMER WING TIP

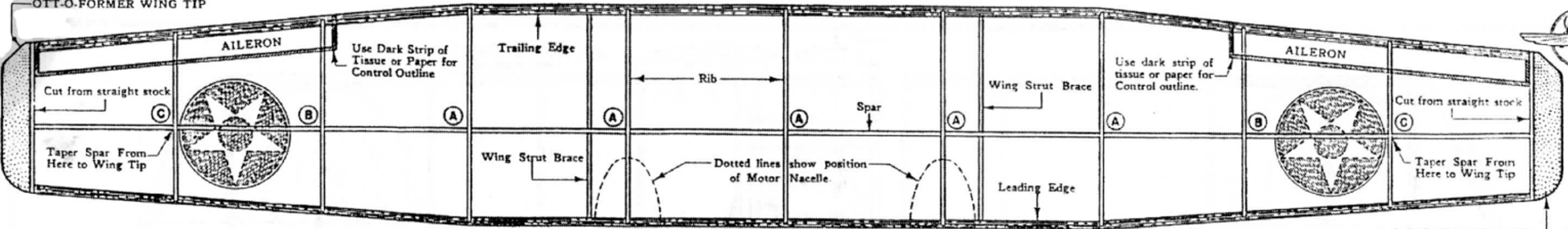

**SPECIAL NOTICE**  
In the future "Joe Ott Kits" with "Ott-O-Formers" may be supplied with a very high quality of Bass, Spruce or Pine for all strips, longerons and for the rib sheets.

**PLAN VIEW**

Typical Rudder Section

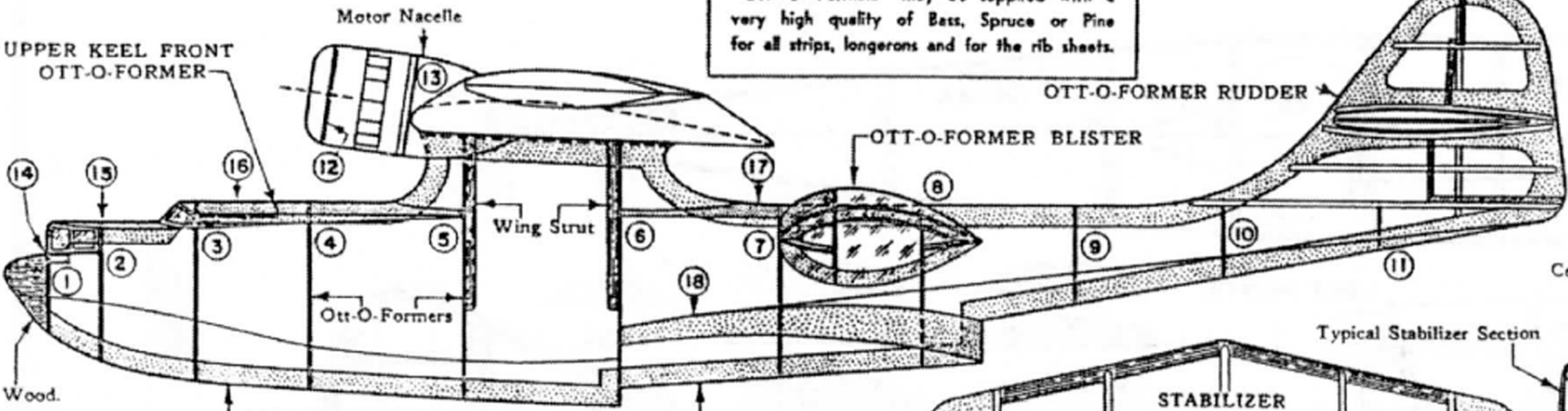
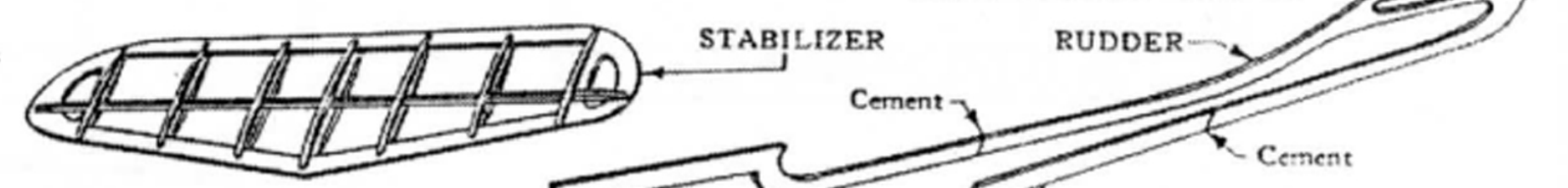

**SIDE VIEW**

LOWER KEEL REAR OTT-O-FORMER

LOWER KEEL FRONT OTT-O-FORMER

Use this full size plan and work with full size parts directly over drawing

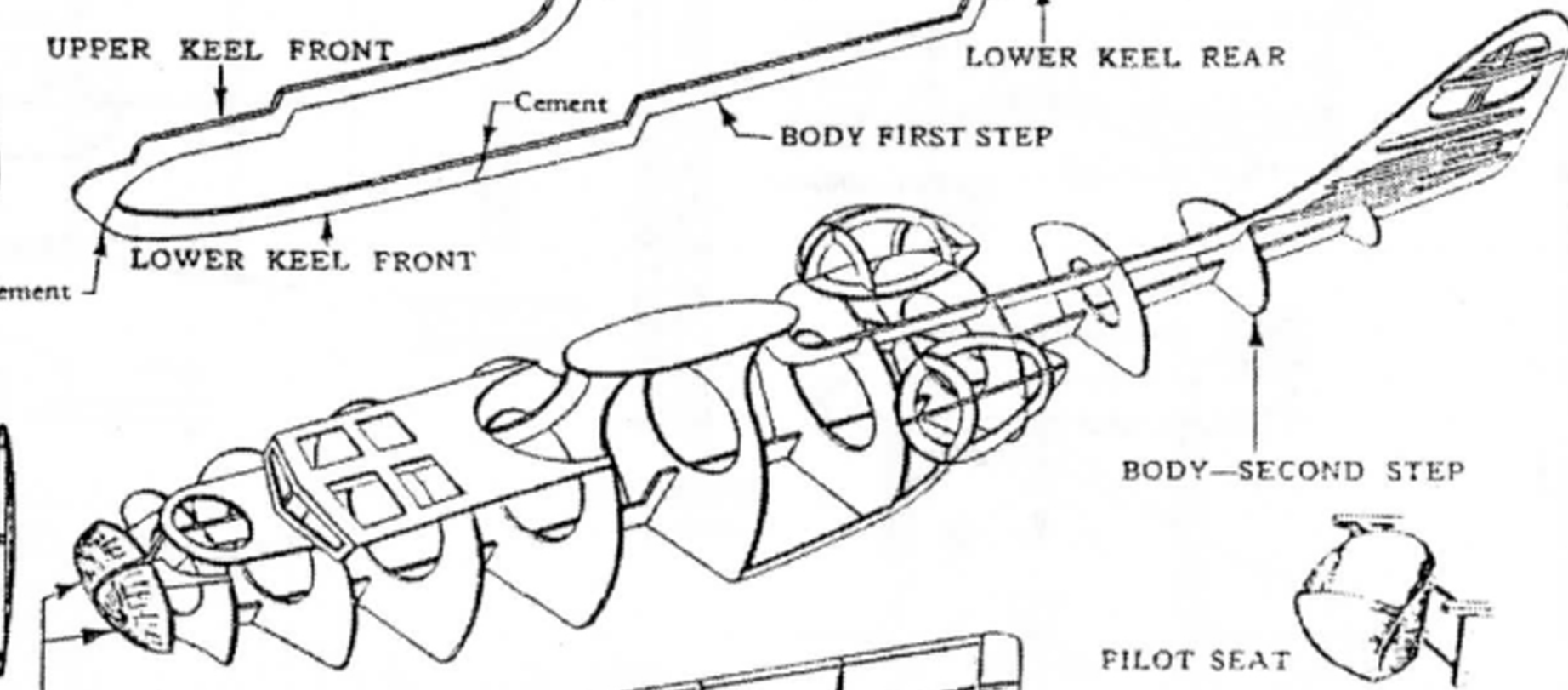
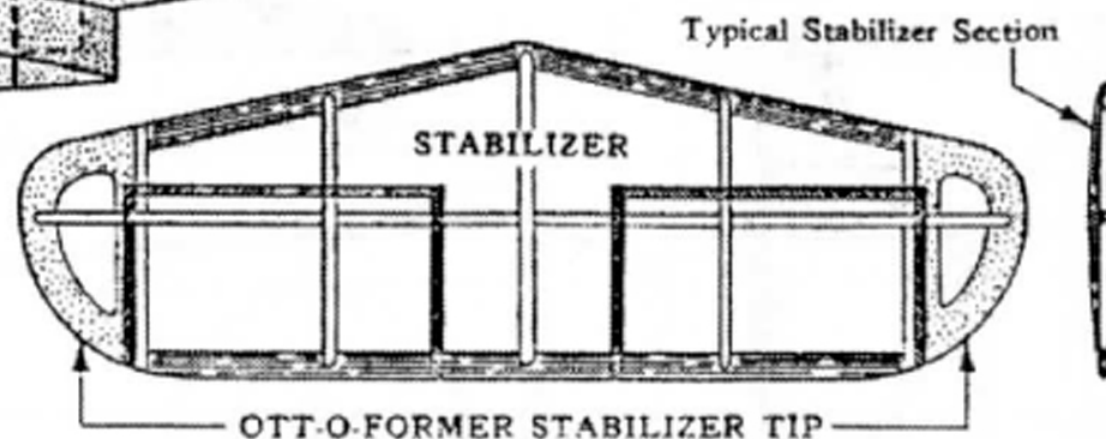

PILOT SEAT  
Made of Heavy Paper and Balsa Wood. Material Not Furnished

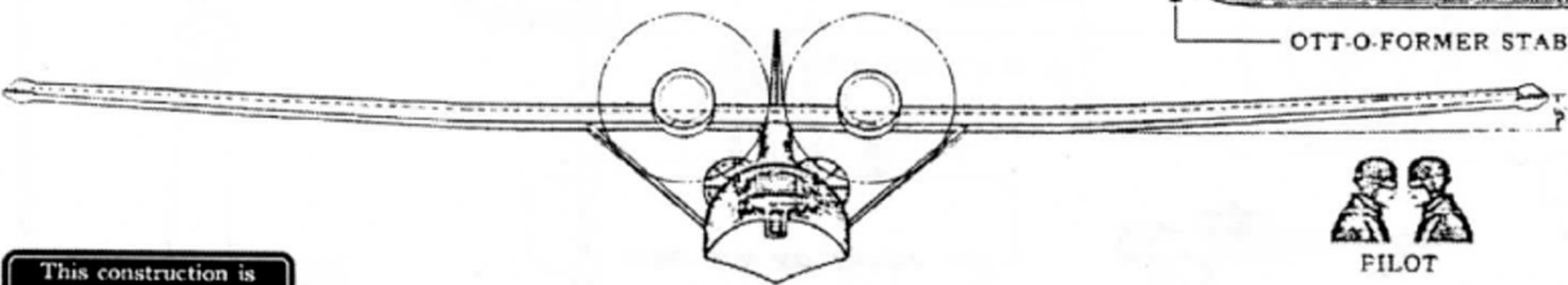

**FRONT VIEW**



PILOT

Cut out black lines to use in outlining Controls

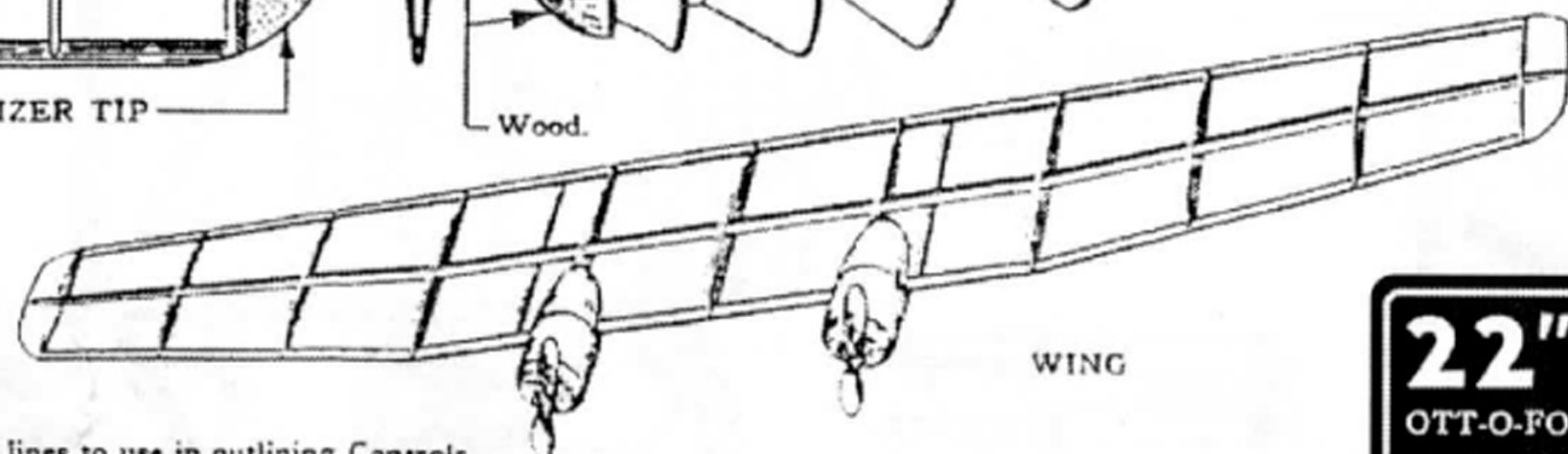

This construction is covered by U. S. Letters Patent Number 2281792

**22" CATALINA**  
OTT-O-FORMER KIT - FULL SIZE PLANS  
NAVY PATROL BOMBER FLYING MODEL No. 2208