



L'ALBATROS . DVa

Chasseur Allemand
Guerre
14/18

Maquette volante taille "PEANUT" par E. Fillon FRANCE

Documents

MRA : 369 . Air Enthusiast : 1 . Mach I : 2
Aéromodeller : Dec 1956 . Sep-Nov 1965
American Modeller : Juin 1969 . RCS : Fev 76
Model Airplane News : Sep 1946 Profile : 9
le FANA : 113-119 . MPM : 100
Fighter Aircraft 14/18
Couleurs de Combat

Marque de
Fabrique



Helice ϕ 150
pas 1,5
deux bois ou
plastique +2,30

CG

suivant
modèles

Cloison

Cloison

Leegewicht : 600 kg
Nutzlast : 235 kg
Gesamttgewicht : 15 kg

bambou
1x1,5

Moteur MERCEDES 180 CV
Roue
Libre

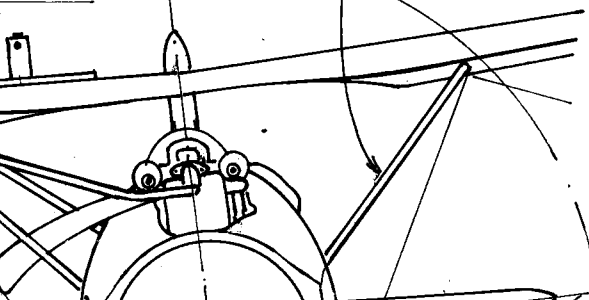
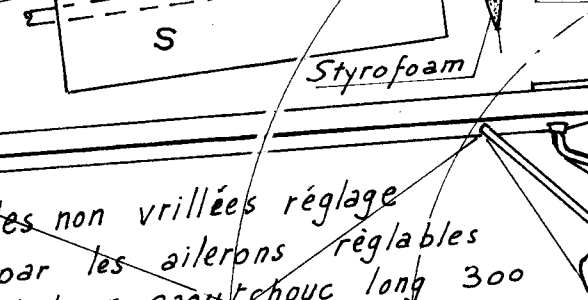
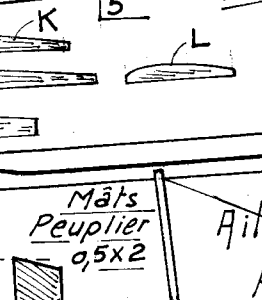
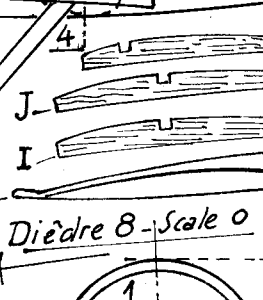
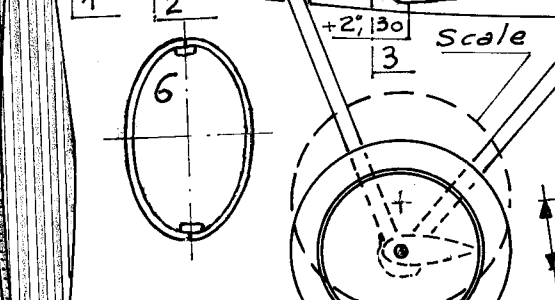
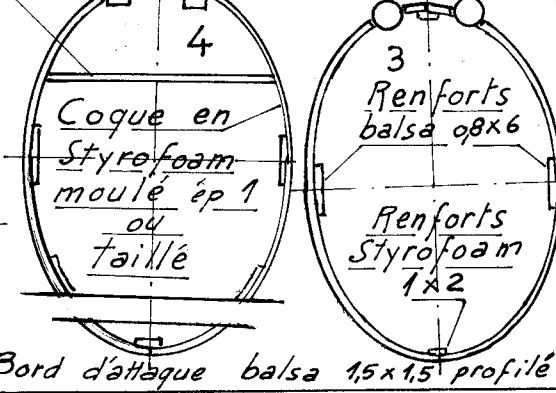
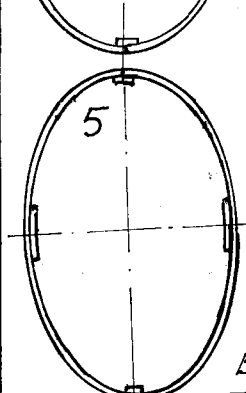
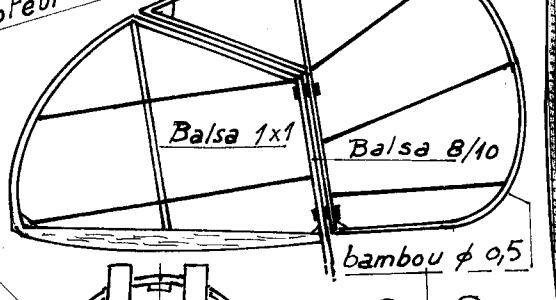
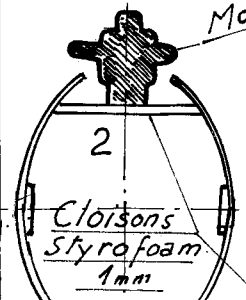

Dièdre 8 - Scale 0

Mâts
Peuplier
0,5x2

Ailes non vrillées réglage
par les ailerons réglables
Moteur caoutchouc long 300
Poids 2,2 à 3 gr suivant
poids de la cellule

Recouvrement papier
Japon fin + enduit dilué

Dièdre 16
Scale 7

Aalsa
20/10

Roue
balsa
 ϕ 28

train
bambou 1x2

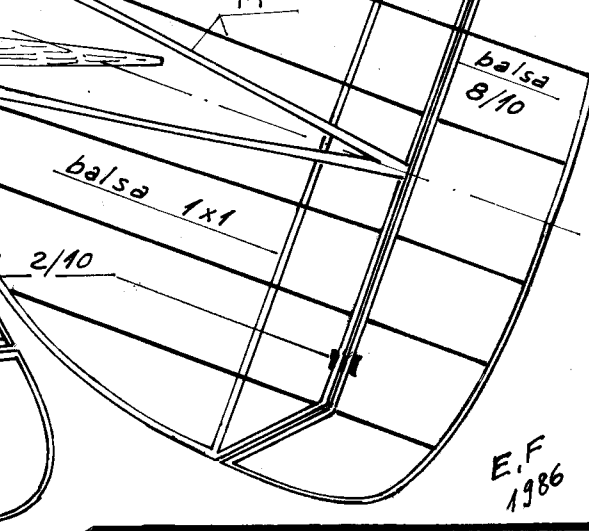
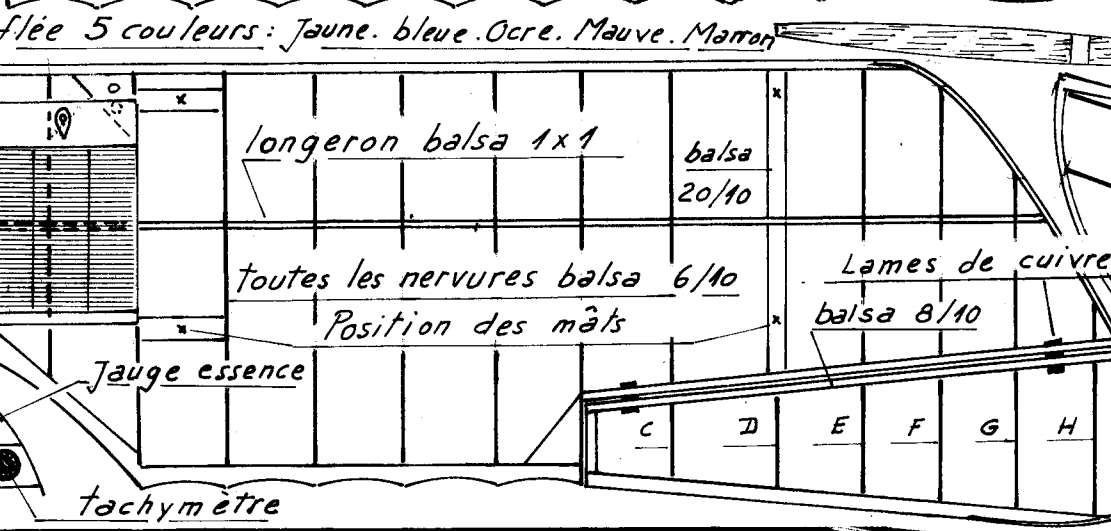
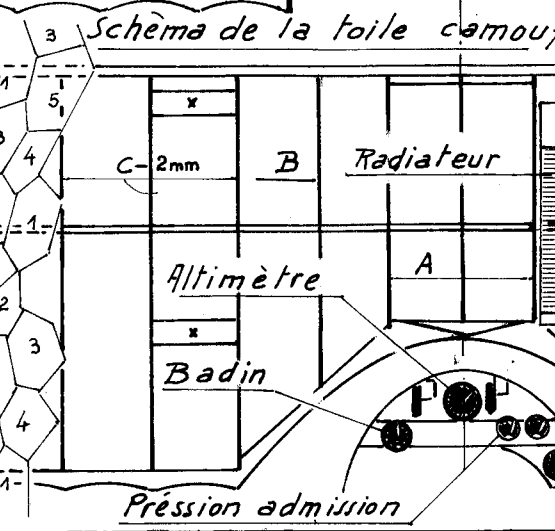
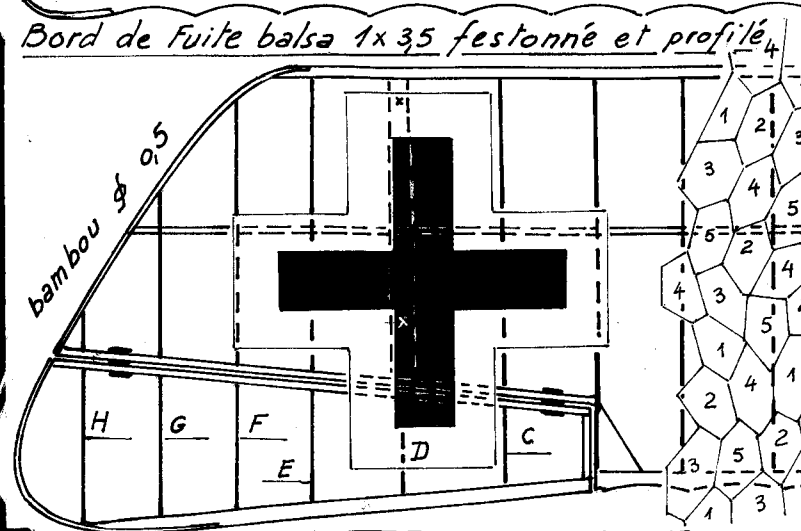
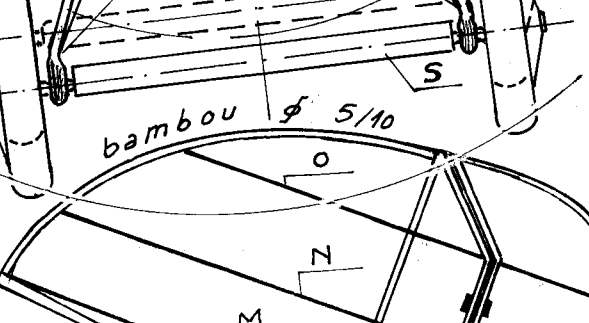
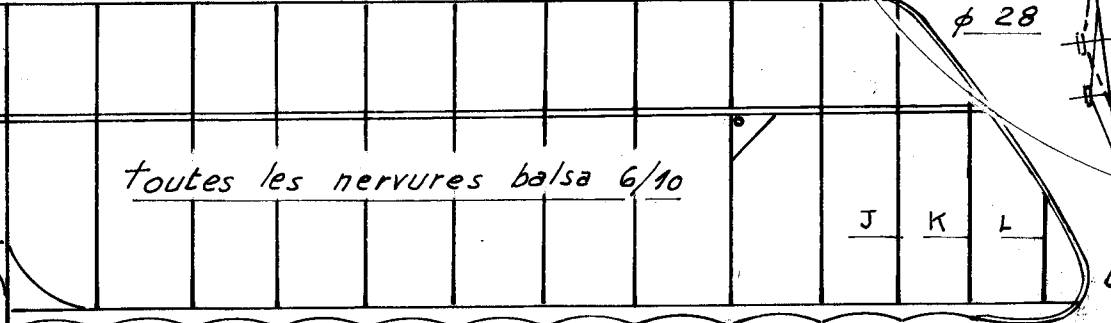
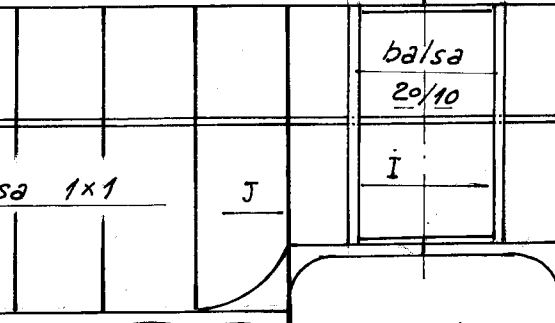
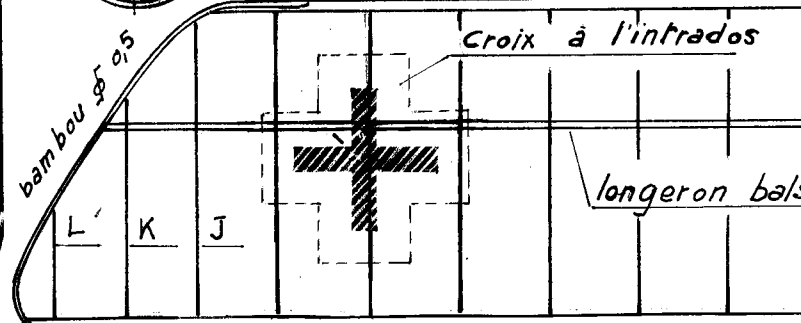

Bord de fuite balsa 1x35 festonné et profilé

Schema de la toile camouflée 5 couleurs : Jaune, bleu, Ocre, Mauve, Marron

bambou ϕ 0,5

Croix à l'intrados

balsa
20/10

longeron balsa 1x1

toutes les nervures balsa 6/10

bambou ϕ 5/10

bambou ϕ 0,5

Altimètre

Badin

Pression admission

tachymètre

longeron balsa 1x1

balsa
20/10

toutes les nervures balsa 6/10
Position des mâts

Lames de cuivre 2/10
balsa 8/10

E.F.
1986