

SHIELD
PATTERN

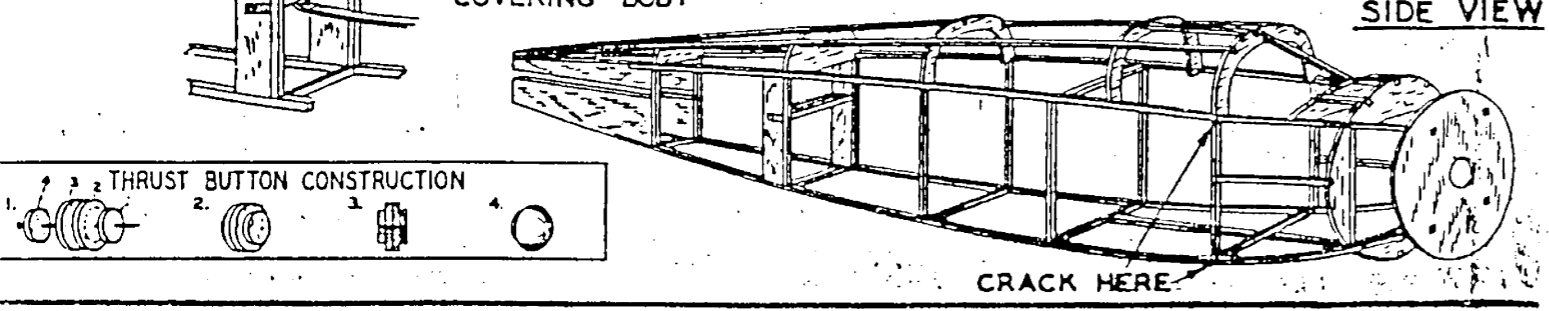

COLOR SCHEME
ENTIRE MODEL
IS RED

CABIN PATTERNS

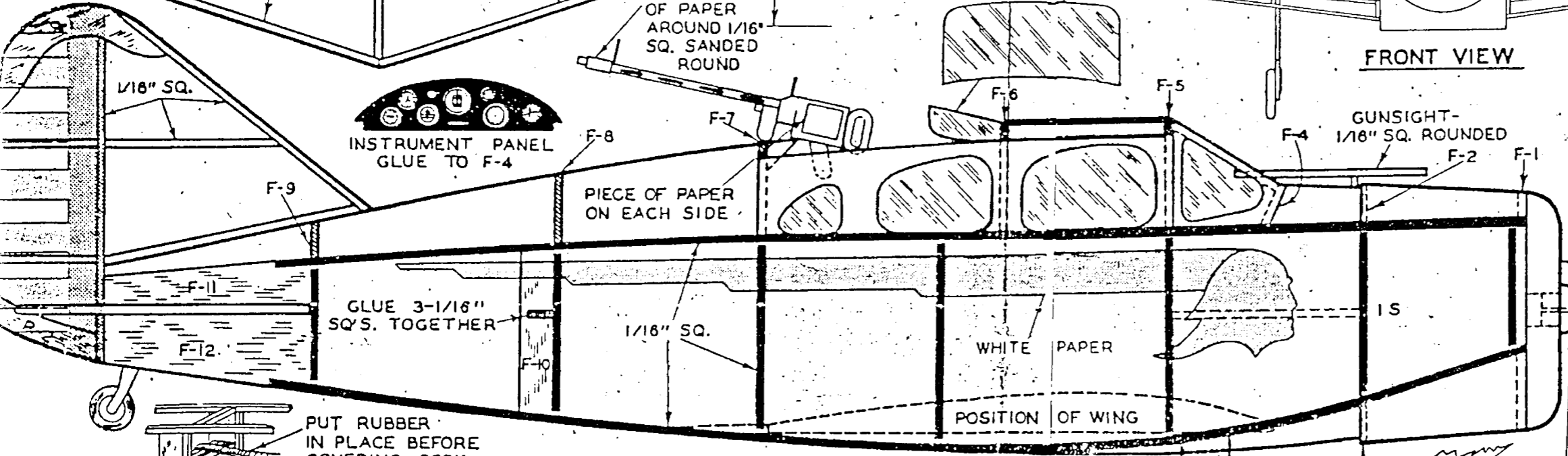
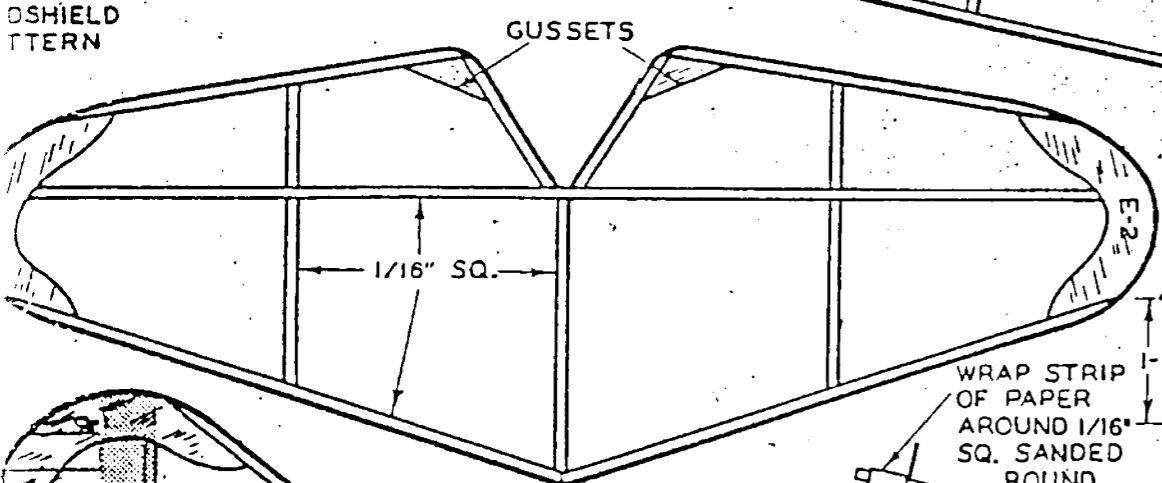
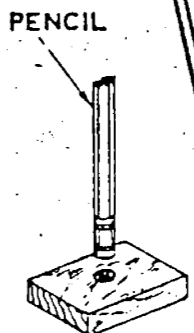
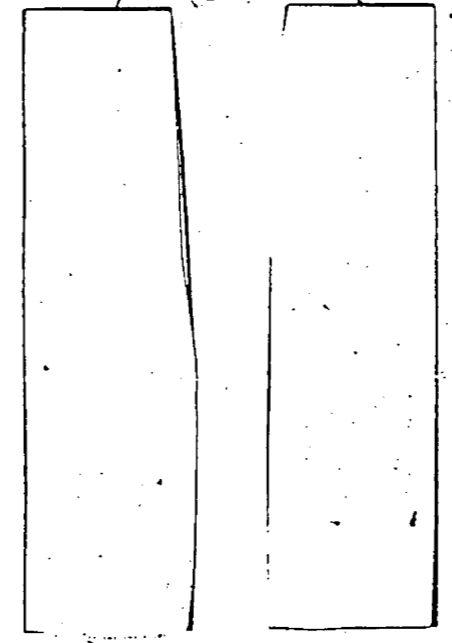

PENCIL
CUTTING
NOSEBLOCK
HOLE

FRONT VIEW

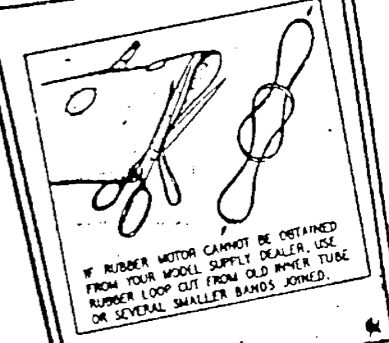
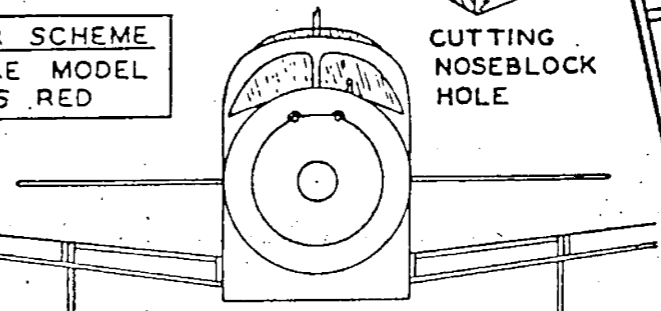

IF RUBBER MOTOR CANNOT BE OBTAINED
FROM YOUR WOOD SUPPLY DEALER, USE
RUBBER LOOP CUT FROM OLD RHYME TUBE
OR SEVERAL SMALLER BANDS JOINED.

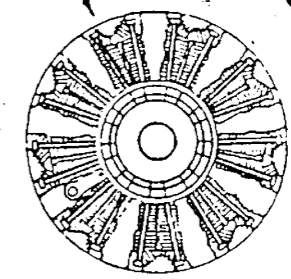

STICK TO FRONT
OF COWLING

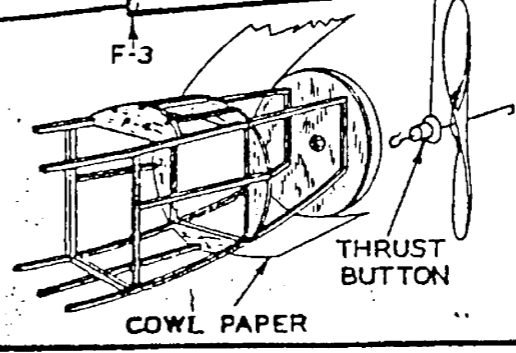

COWL PAPER

THRUST
BUTTON

SPARTAN FIGHTER

WINGSPAN 20" LENGTH 12"
DRAWN BY *John Hamrick* KIT NO. A34

WING LIGHT-SCRAP WOOD

LANDING
GEAR
STRUT

LANDING GEAR
DETAIL

1/16" SQ.

1/16" SQ. STRIPS

1/16" Q. ROUNDED

WING LIGHT-SCRAP WOOD