

NOSE PLUG

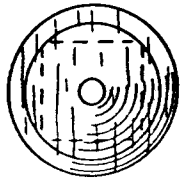

CELLULOID WINDSHIELD

FULL SIZE WING RIBS  
CUT FROM 1/32" OR 1/20"  
SHEET 15 REQUIRED

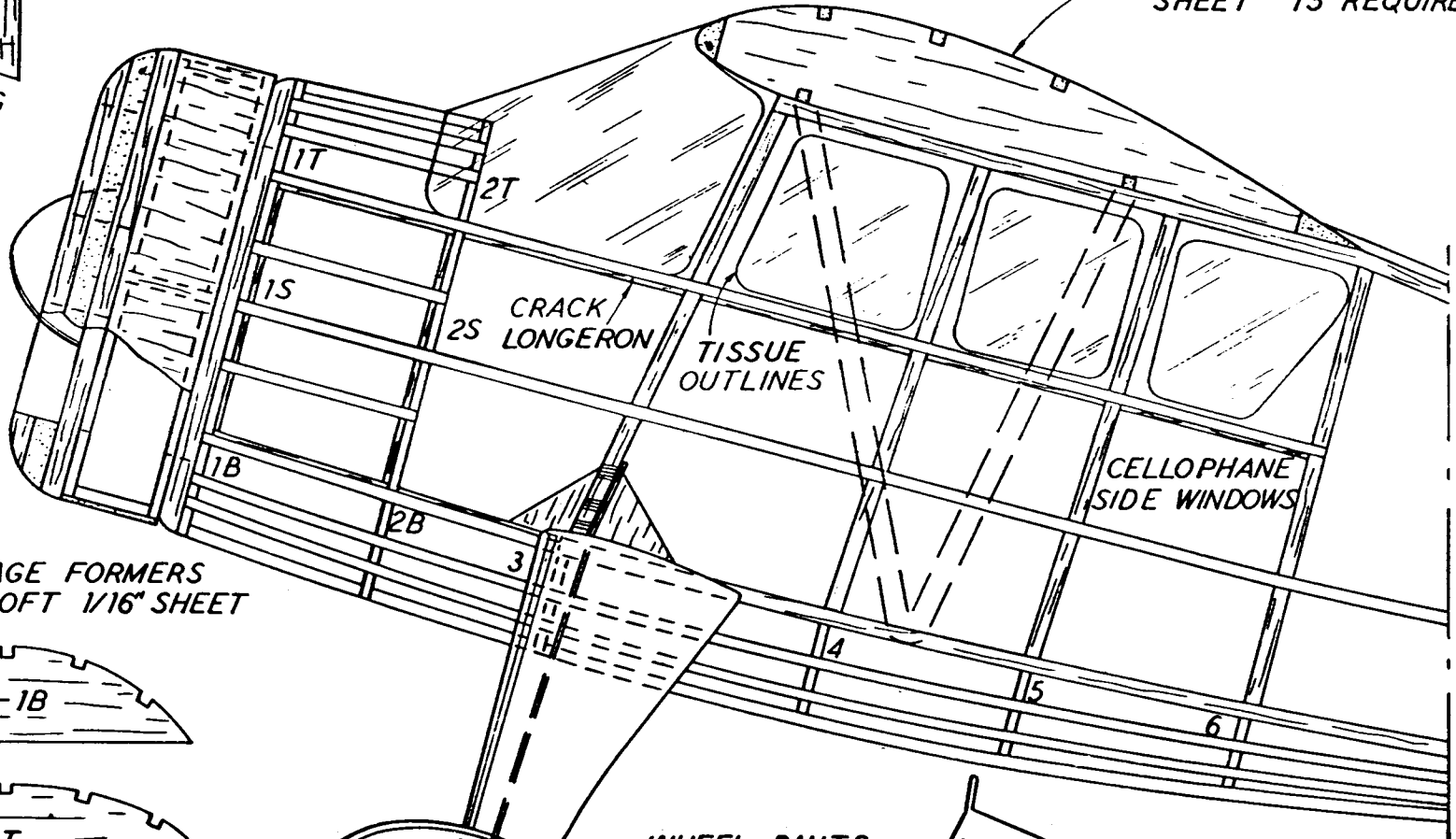

ALL FUSELAGE FORMERS  
CUT FROM SOFT 1/16" SHEET

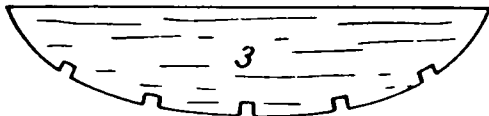
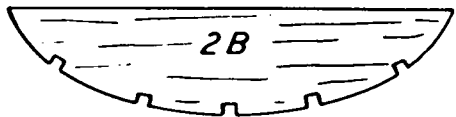
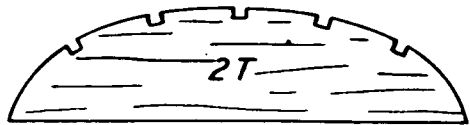
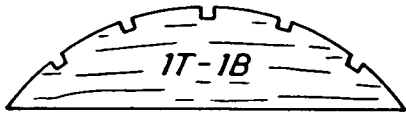

WHEEL PANTS  
ARE OPTIONAL

BALSA WHEELS

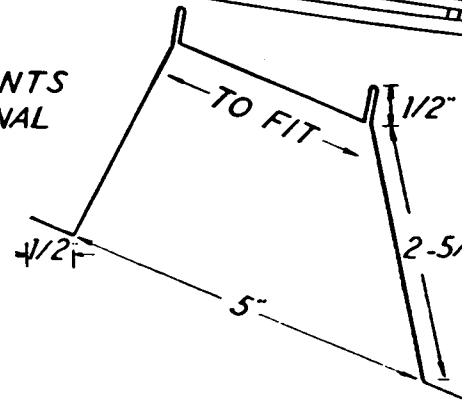

040 MUSIC WIRE  
2-5/8" LANDING GEAR  
STRUT. BIND  
TO FUSELAGE

FRONT VIEW  
1/3 SCALE

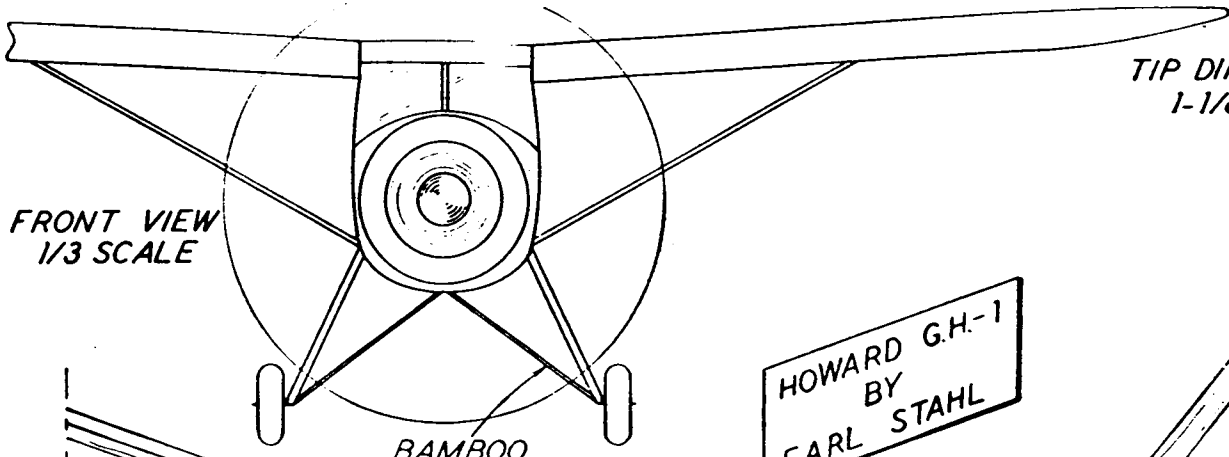

BAMBOO

HOWARD G.H.-1  
BY  
EARL STAHL

TIP DIHEDRAL  
1-1/8"

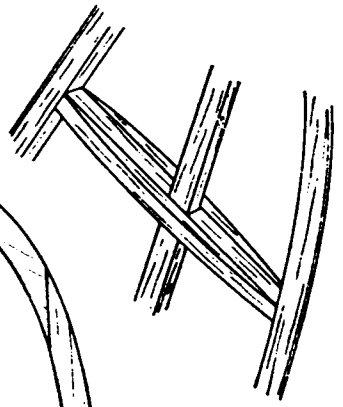

TAIL GROUP  
CONSTRUCTION

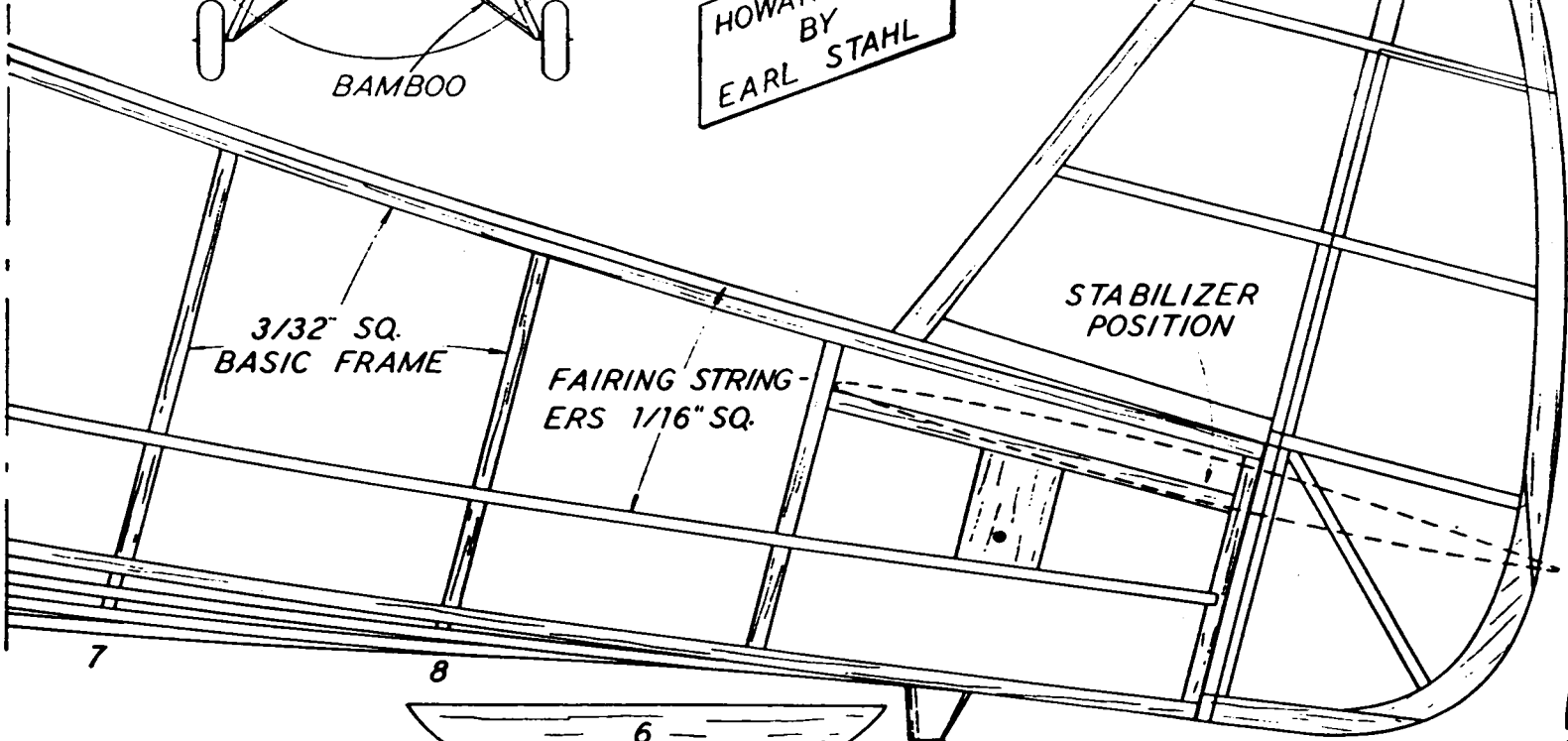

3/32" SQ.  
BASIC FRAME

FAIRING STRINGERS  
1/16" SQ.

STABILIZER  
POSITION

1/16" SHEET

7

8

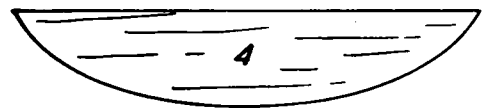

4

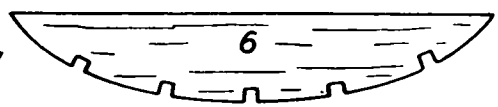

6

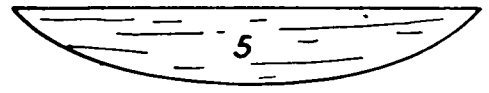

5

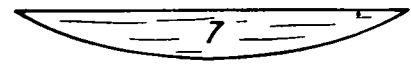

7

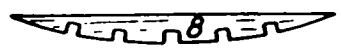

8



.040 MUSIC WIRE  
PROP. SHAFT

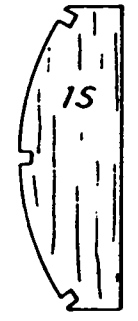

15



25

2 EACH REQ'D

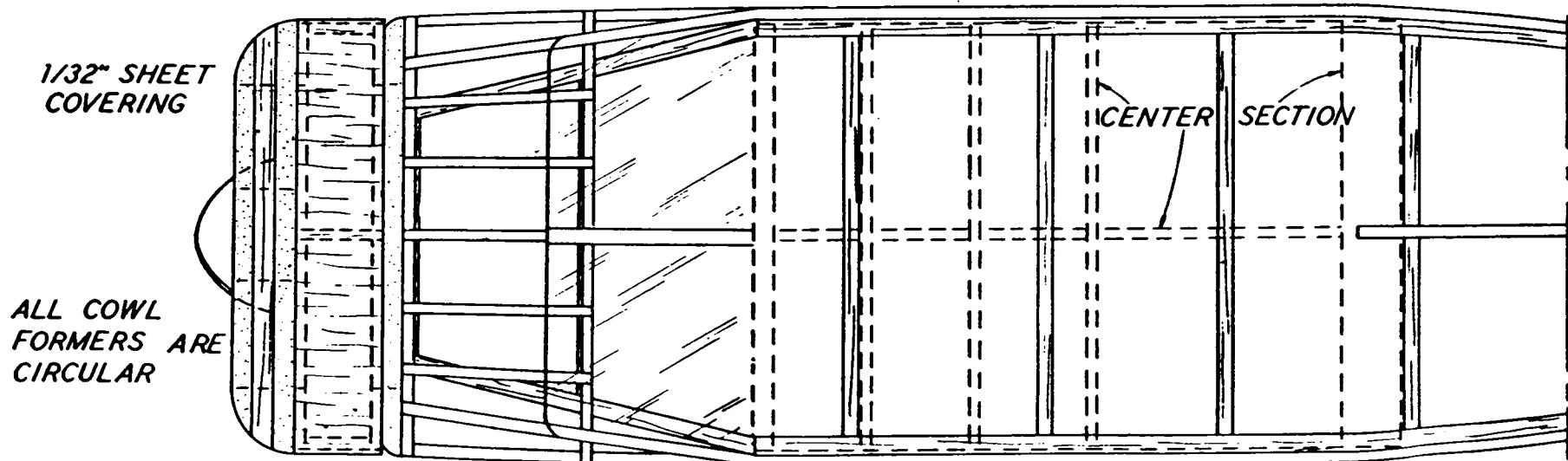
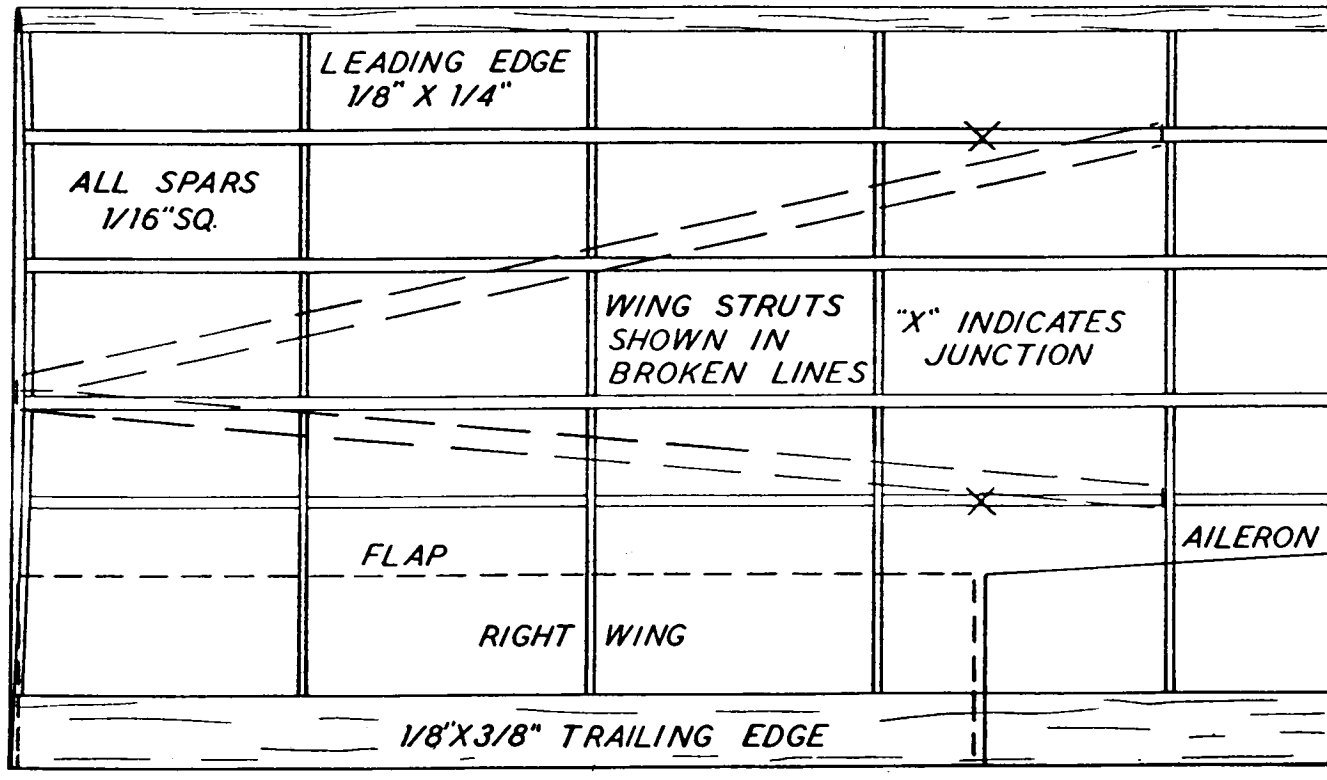
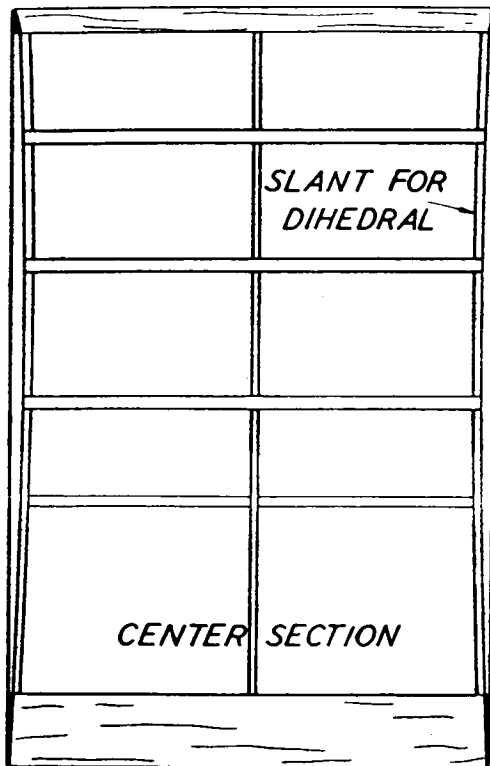

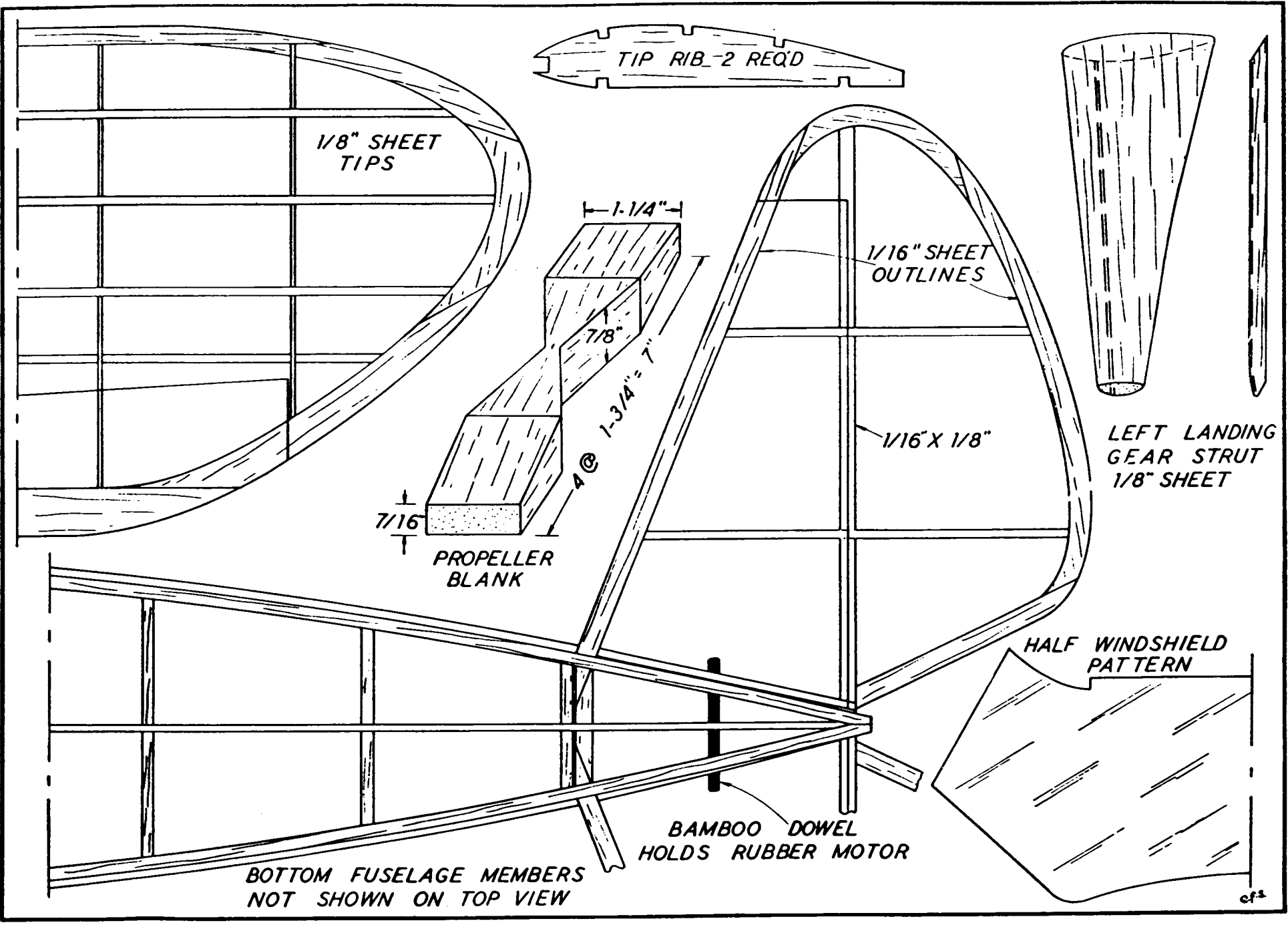

TIP RIB - 2 REQ'D

1/8" SHEET TIPS

1-1/4"

7/8"

4 @ 1-3/4" = 7"

7/16"

PROPELLER BLANK

1/16" SHEET OUTLINES

1/16" X 1/8"

LEFT LANDING GEAR STRUT 1/8" SHEET

HALF WINDSHIELD PATTERN

BAMBOO DOWEL HOLDS RUBBER MOTOR

BOTTOM FUSELAGE MEMBERS NOT SHOWN ON TOP VIEW