

SHEET TIPS

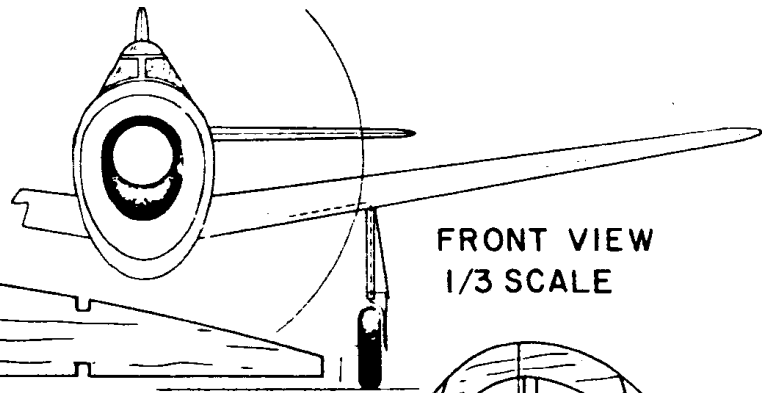

FRONT VIEW
1/3 SCALE

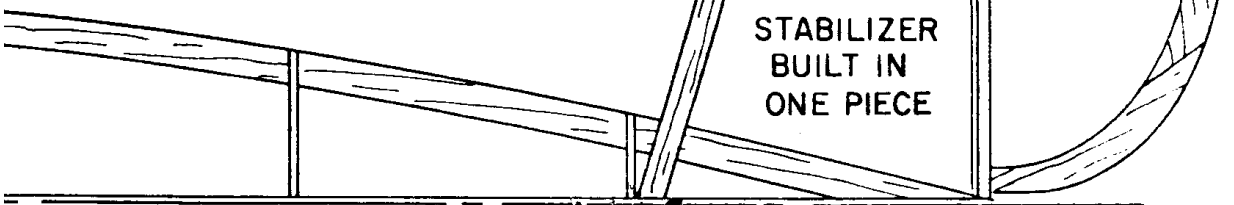
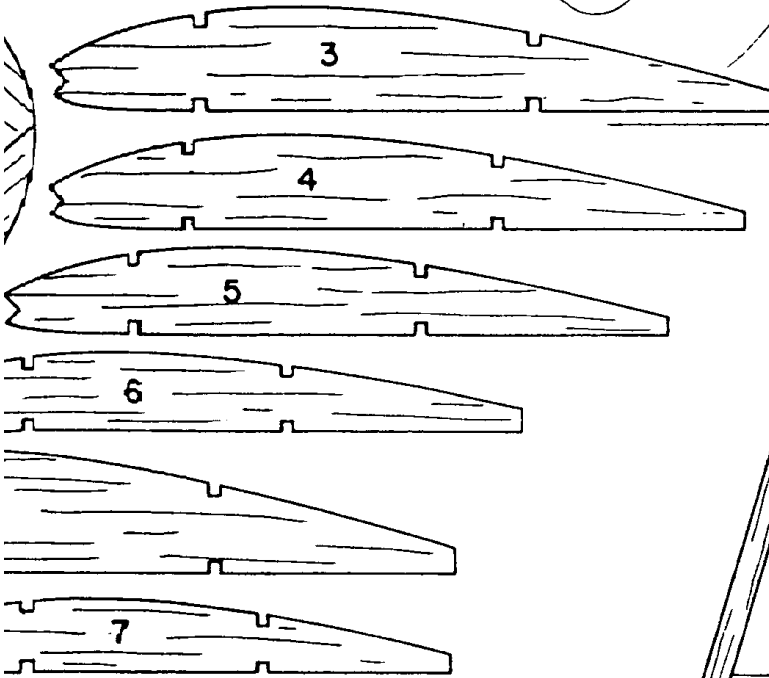

1 16"
SHEET
OUTLINES

1/16 X 1/8"

STABILIZER
BUILT IN
ONE PIECE

LAMINATED
1/8" DISCS

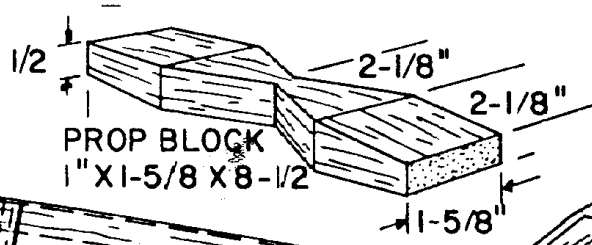

CELLULOID
CANOPY

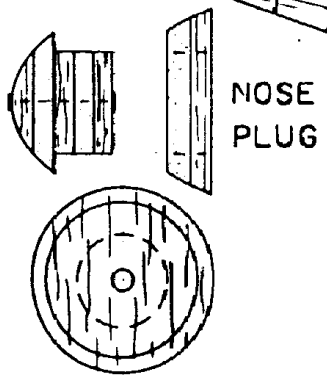
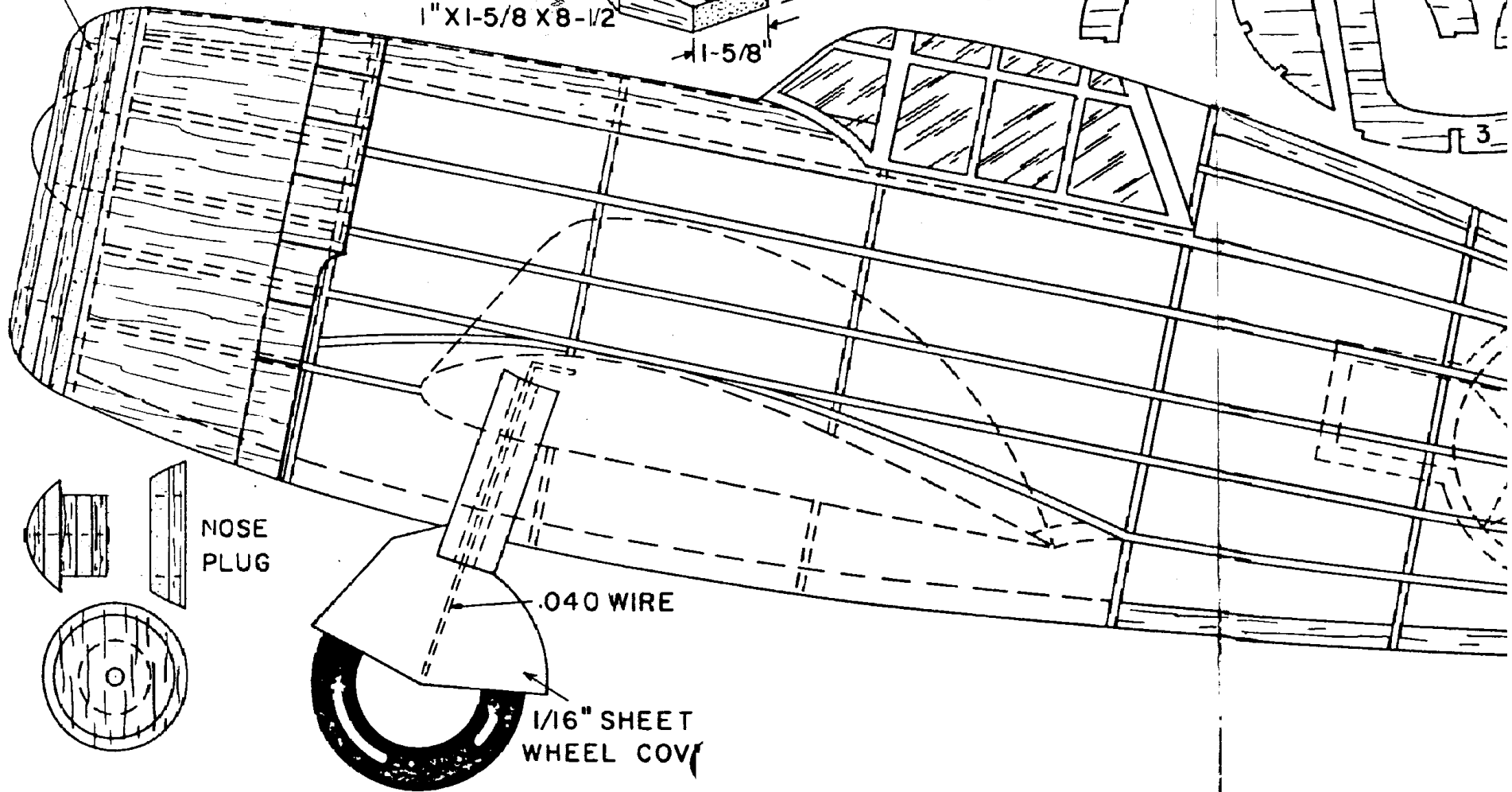
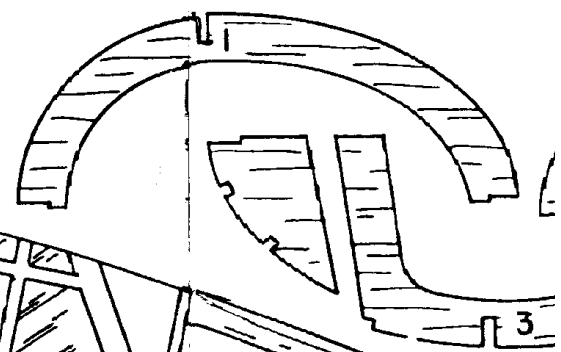

NOSE
PLUG

.040 WIRE

1/16" SHEET
WHEEL COV

