

NOSE PLUG

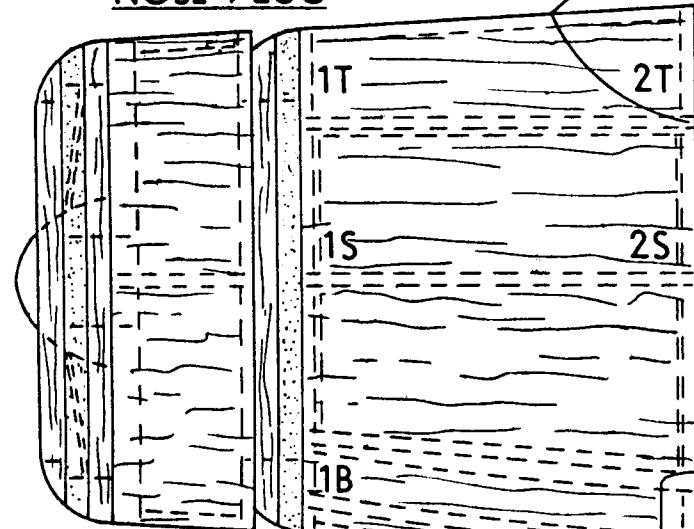

ALL SECTIONS FORWARD OF #1 ARE CIRCULAR

1/32" SHEET ON NOSE & COWL

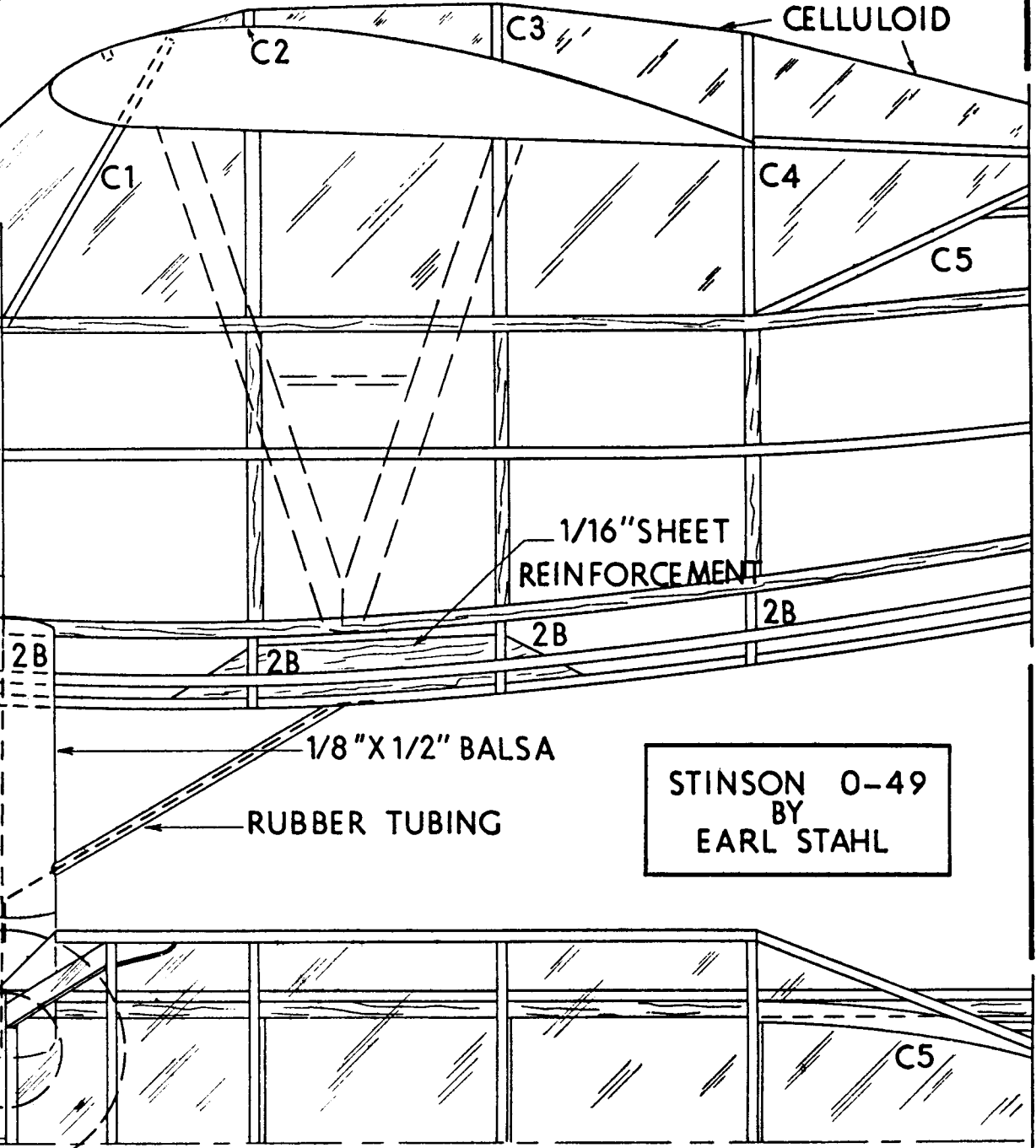
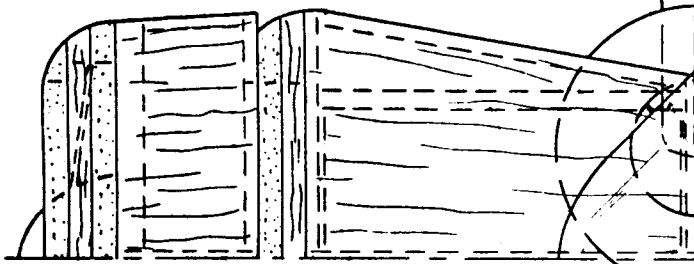

CELLULOID

C2

C3

C1

C4

C5

1/16" SHEET REINFORCEMENT

2B

2B

2B

1/8" X 1/2" BALSA

RUBBER TUBING

STINSON 0-49
BY
EARL STAHL

C5

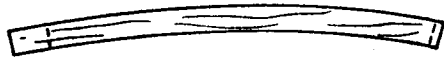

C5 2 REQ'D

FAIRING STRINGERS
1/16" SQ.

STABILIZER
POSITION

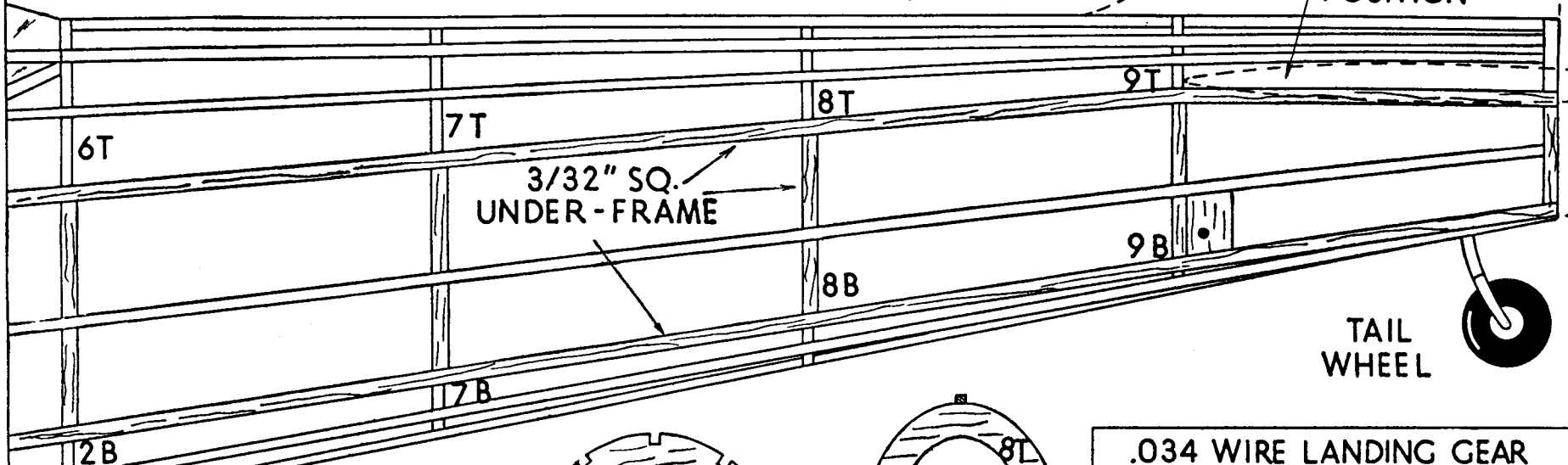

TAIL
WHEEL

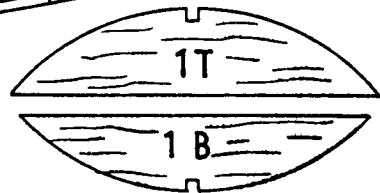

1T

1B

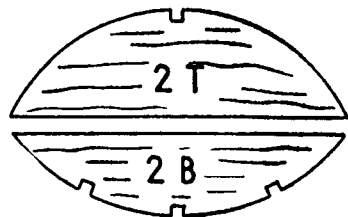

2T

2B

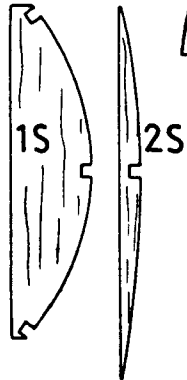

1S

2S

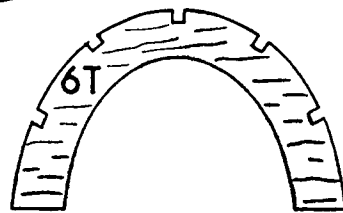

6T

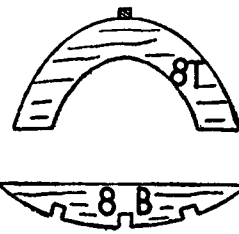

8T

8B

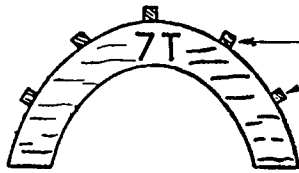

7T

STRINGERS



9T

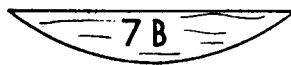

7B

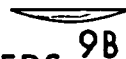

9B

ALL FUSELAGE FORMERS
CUT FROM 1/16" SHEET

.034 WIRE LANDING GEAR
1/2 SCALE

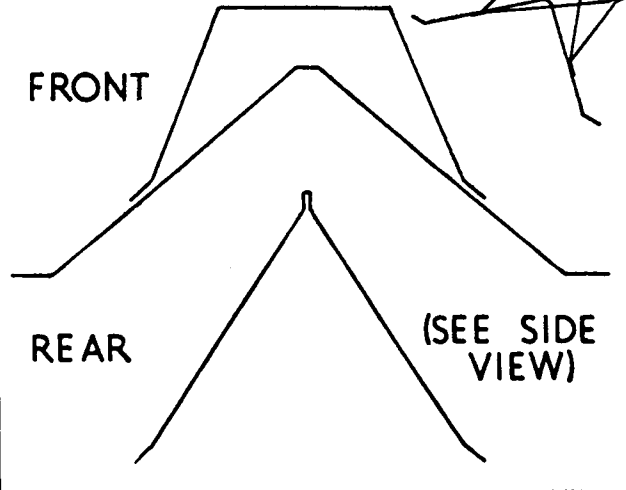

FRONT

REAR

(SEE SIDE VIEW)

BAMBOO PIN

