

CARVE OR LAMINATE NOSE BLOCK

6" PROP

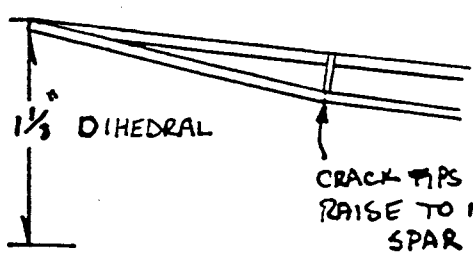

CRACK TIPS AND RAISE TO MEET SPAR

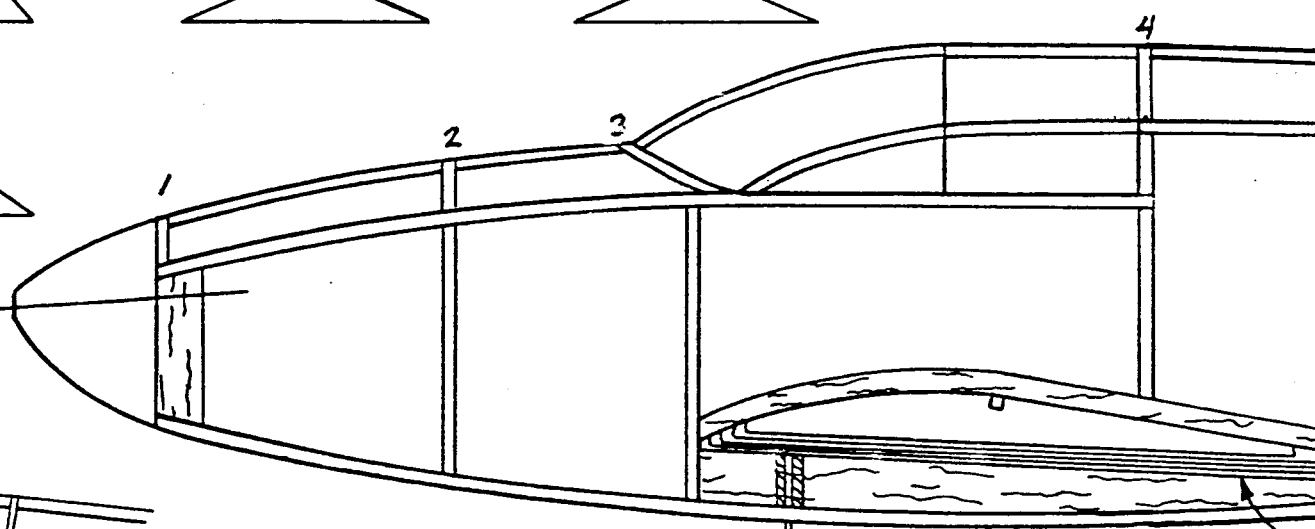
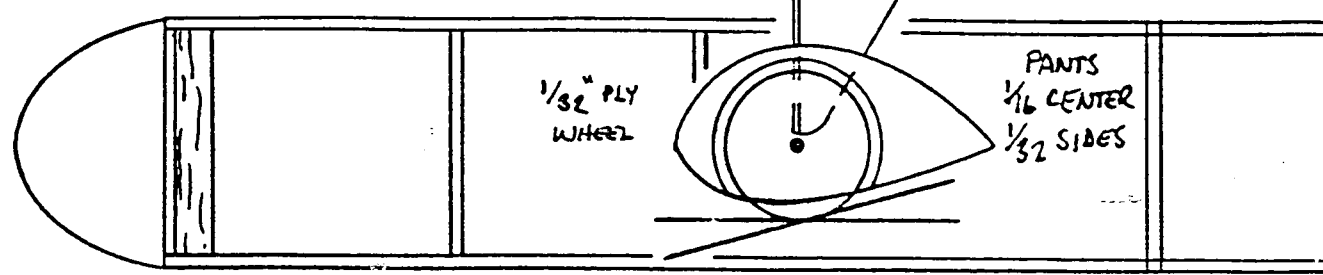
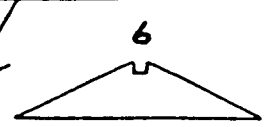
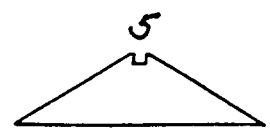

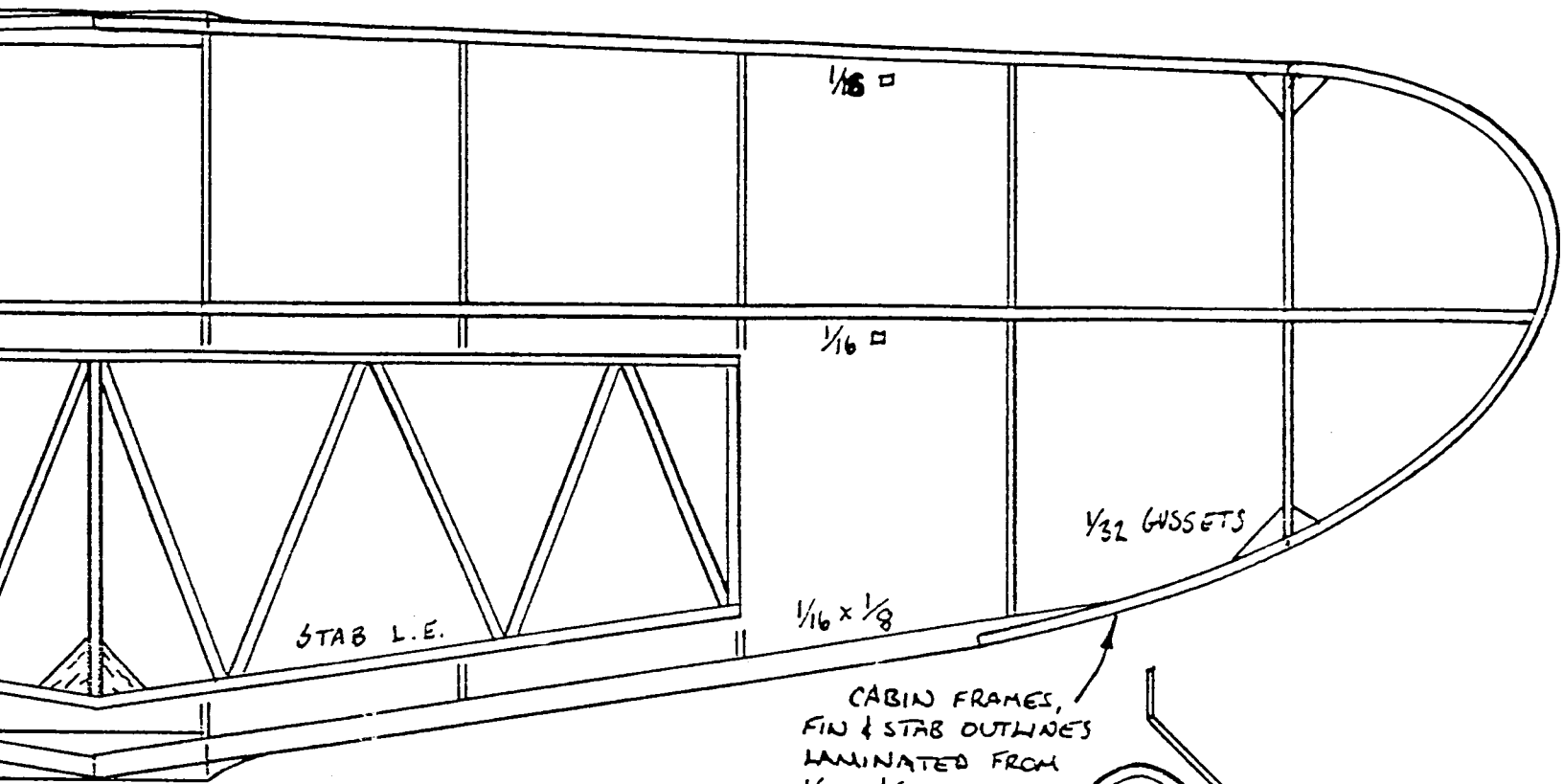

CABIN FRAMES,
 FIN & STAB OUTLINES
 LAMINATED FROM
 $\frac{1}{16} \times \frac{1}{32}$ BALSA

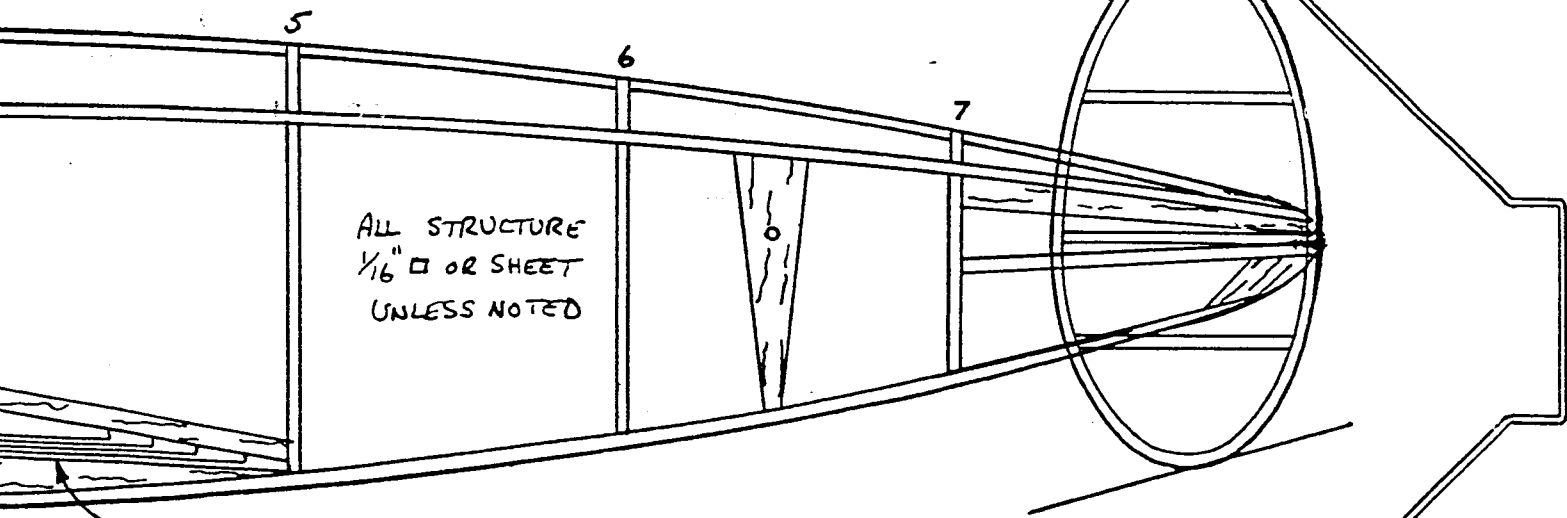

RIB PROFILES
 $\frac{1}{32}$ SHEET

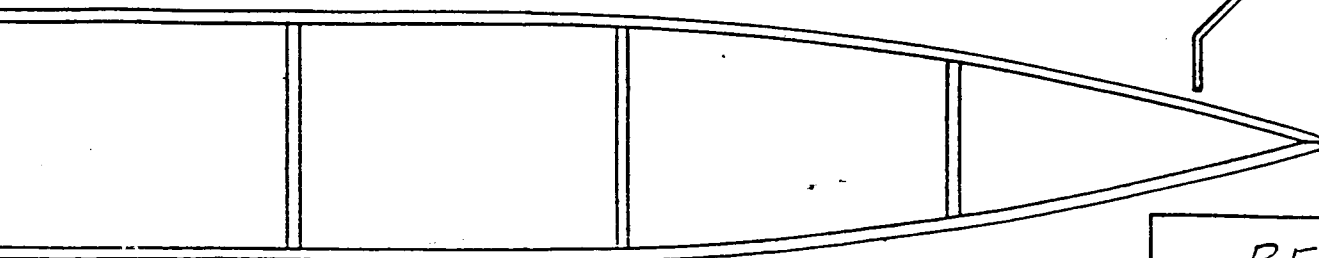
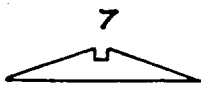

BEETLE
 EMBRYO
 MARK S. YOUNG
 8-29