

18

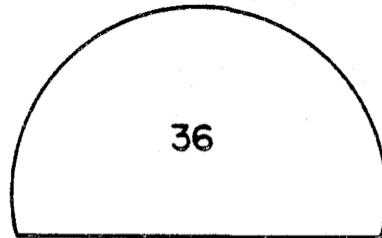

36



66

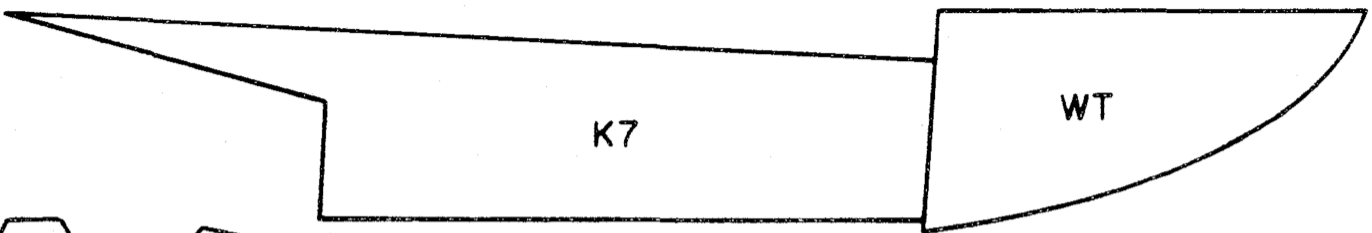

K7

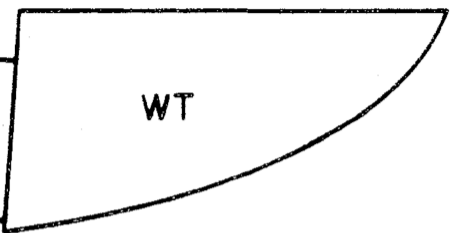

WT

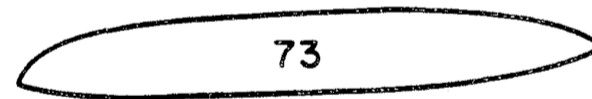

73

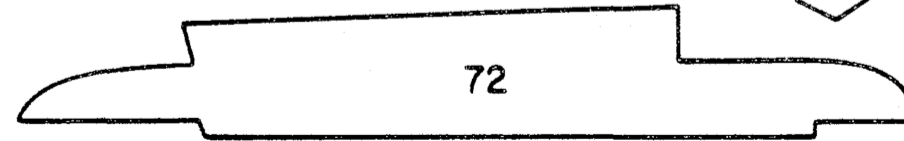

72

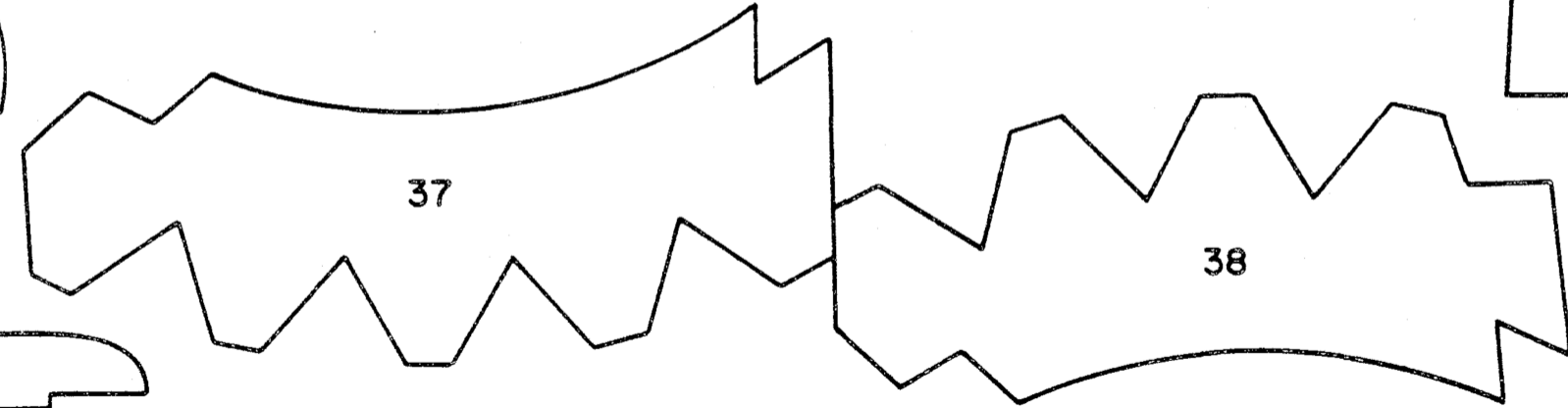

37

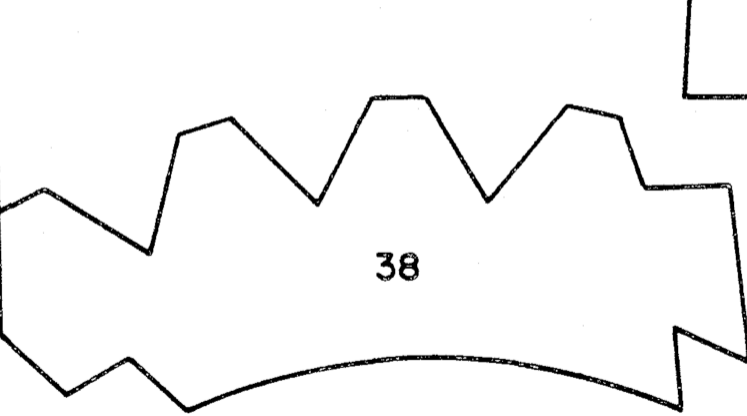

38

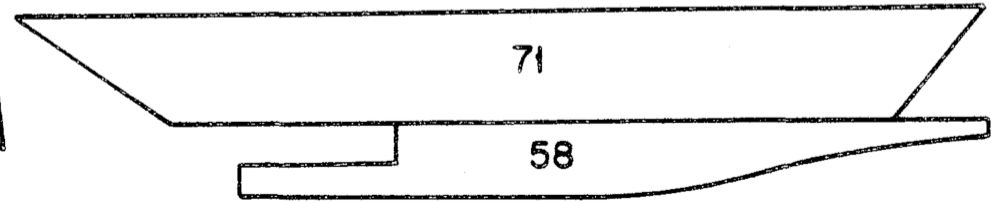

71



58

J-4 SHEET NO. 1, 2 REQ.

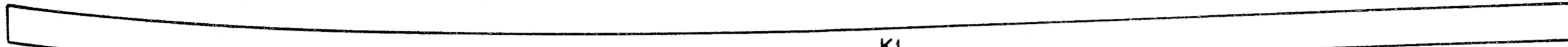

K1



64

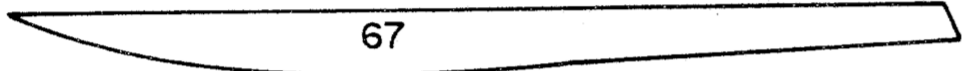

67

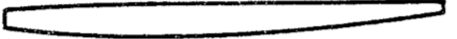

55

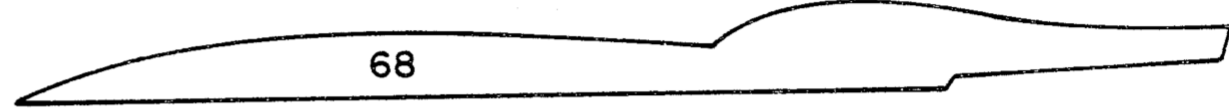

68

J-4 SHEET NO. 2, 2 REQ.

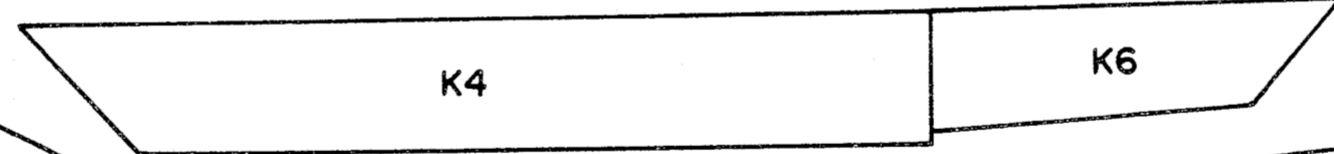

K4

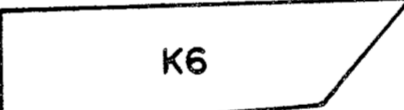

K6



69

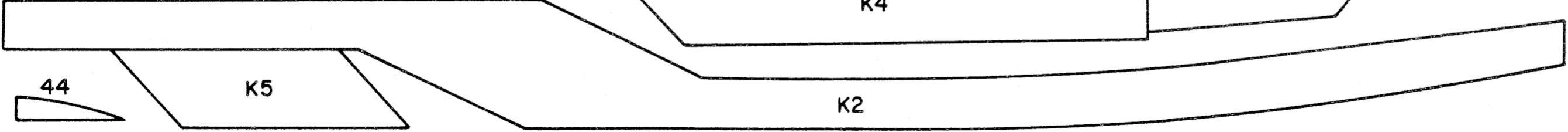

44

K5

K2

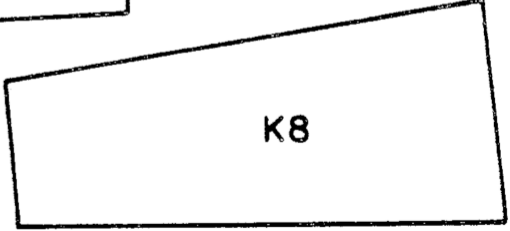

K8

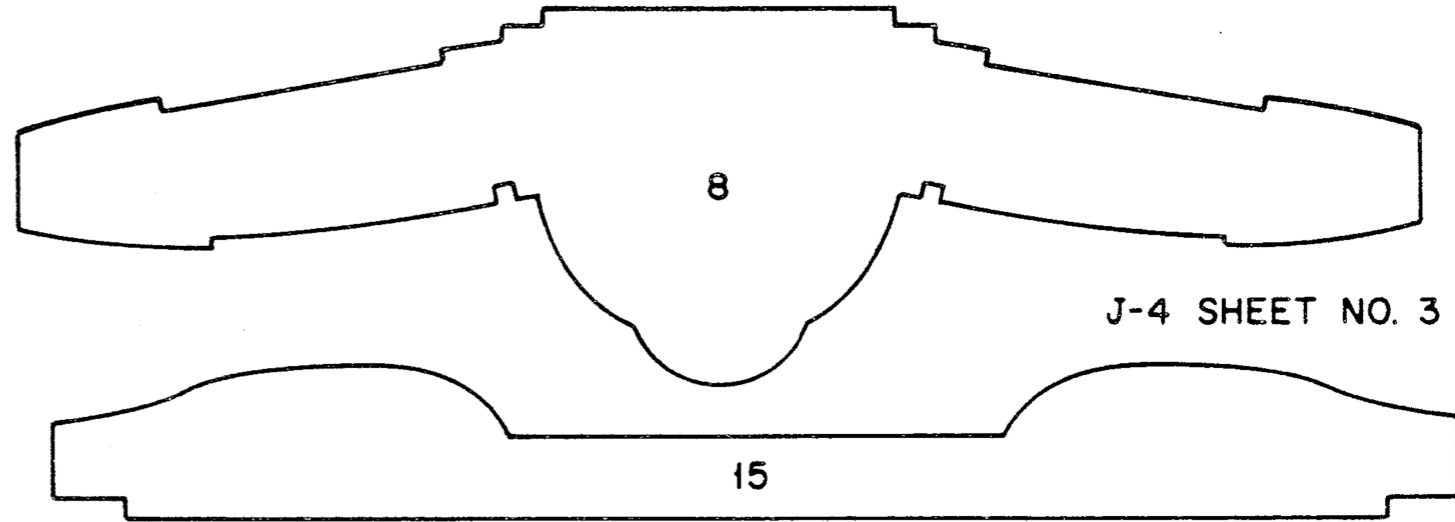
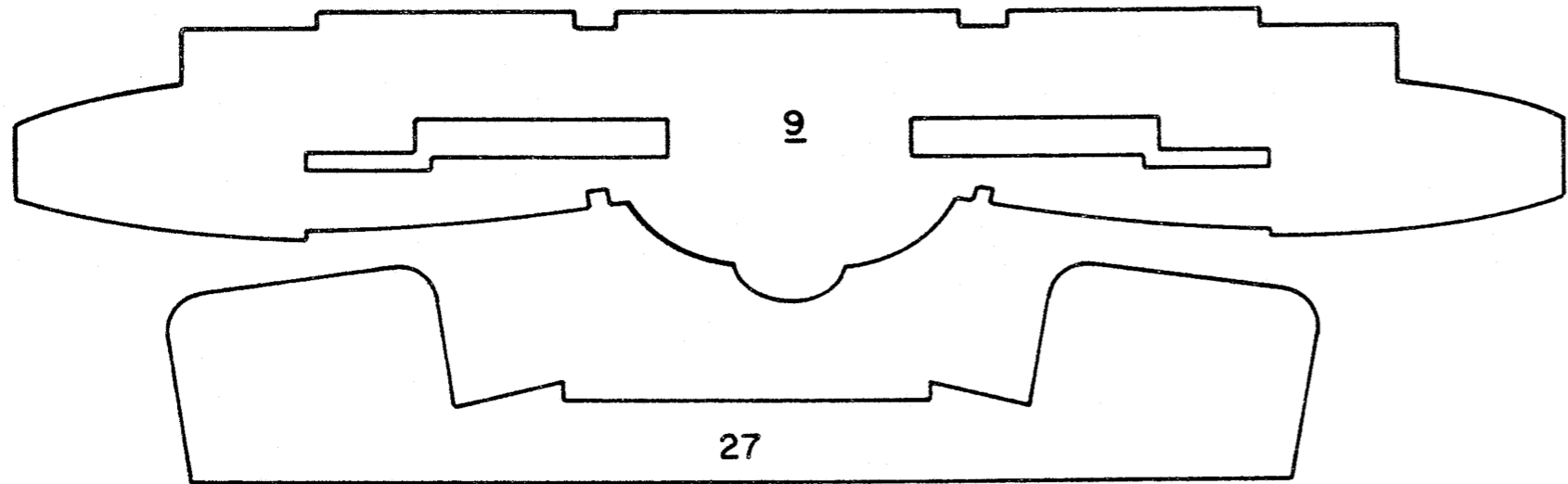

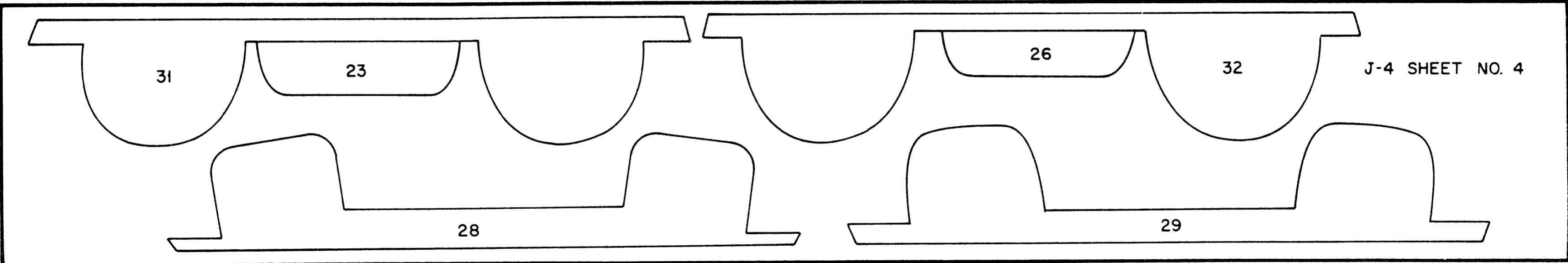

31

23

28

26

32

29

J-4 SHEET NO. 4

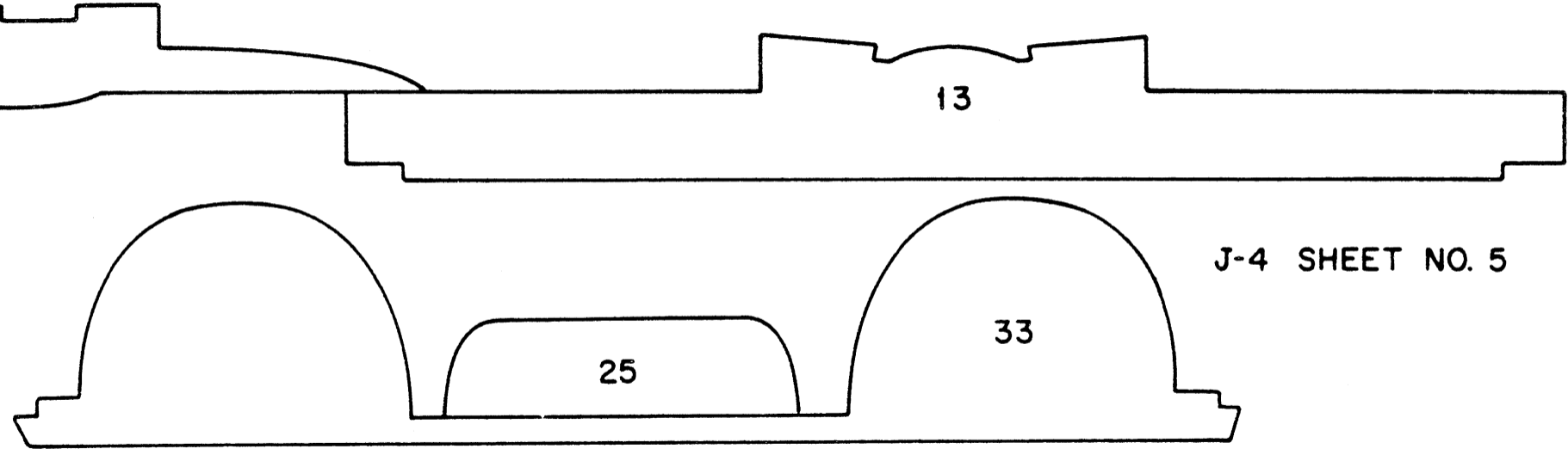
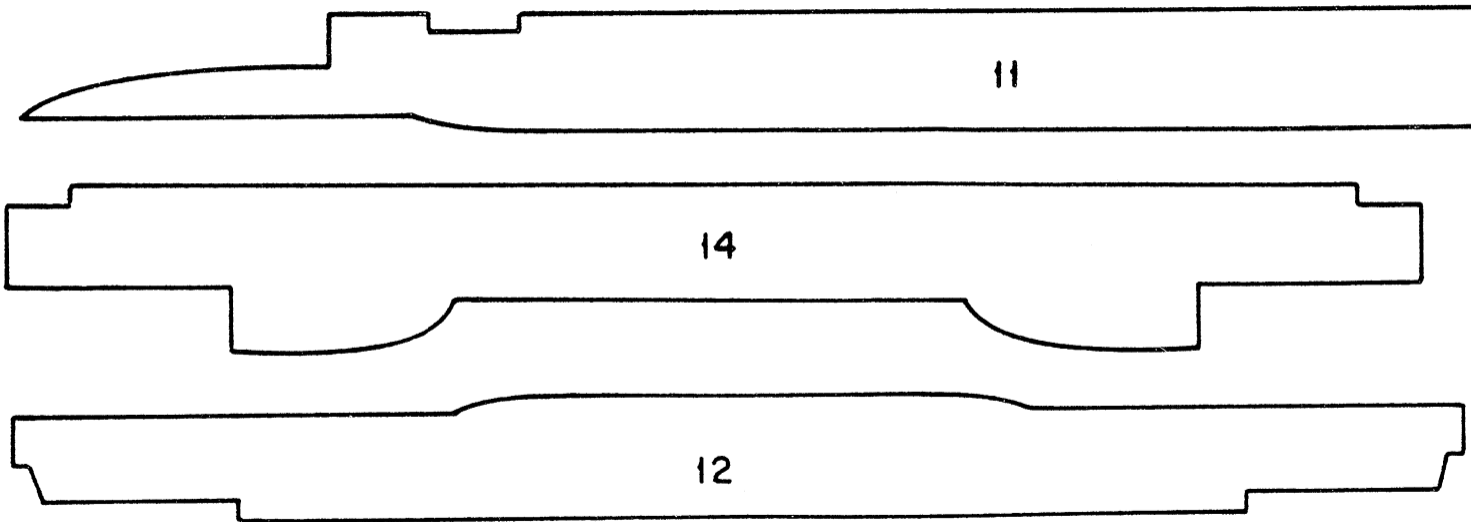

J-4 SHEET NO. 5

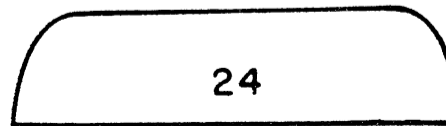
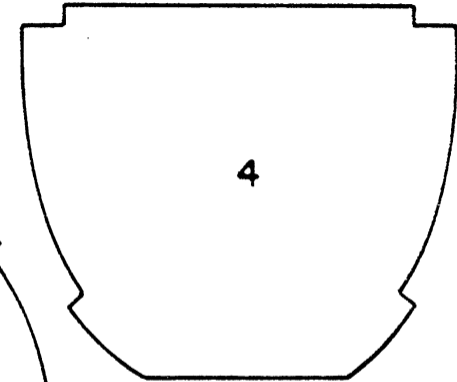
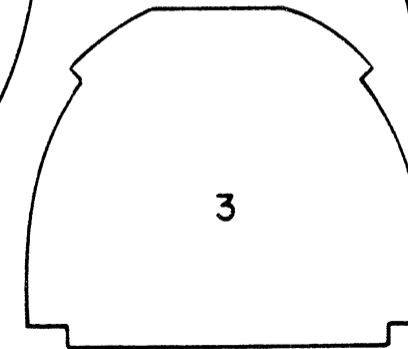
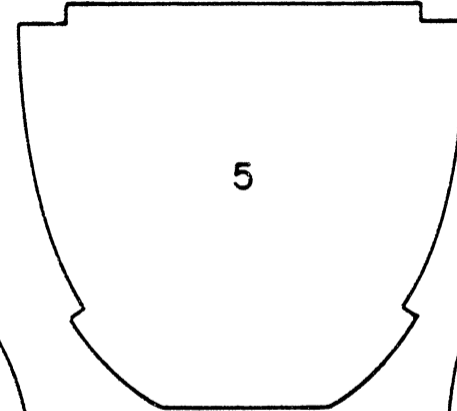
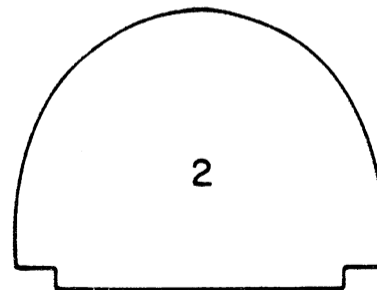
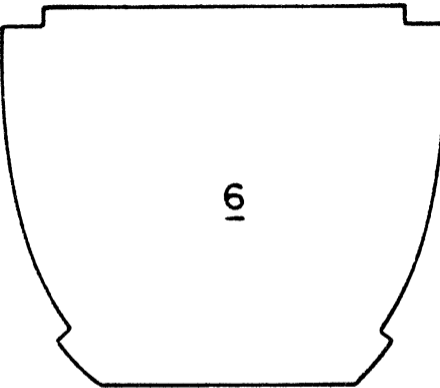
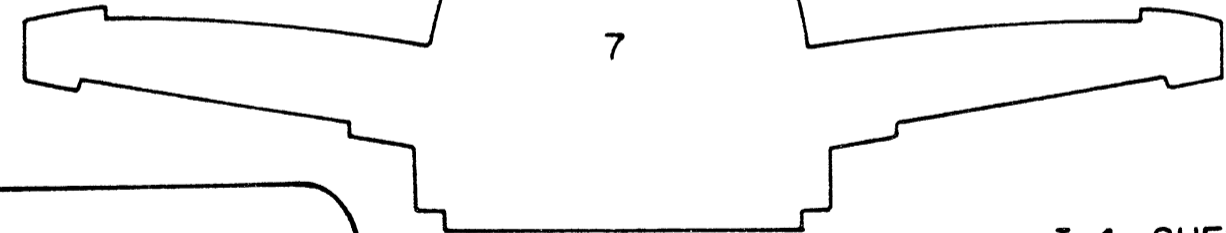
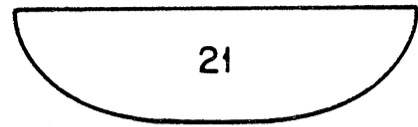

J-4 SHEET NO. 6

J-4 SHEET NO. 7

20

30

17

10

16

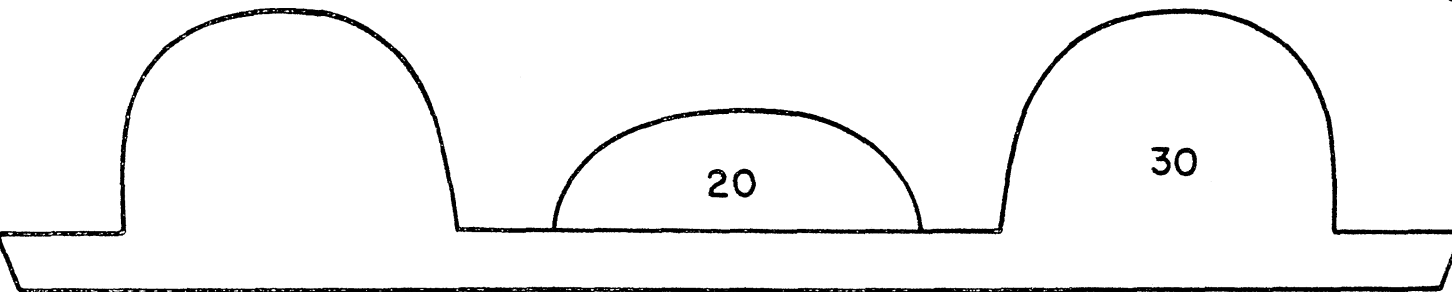
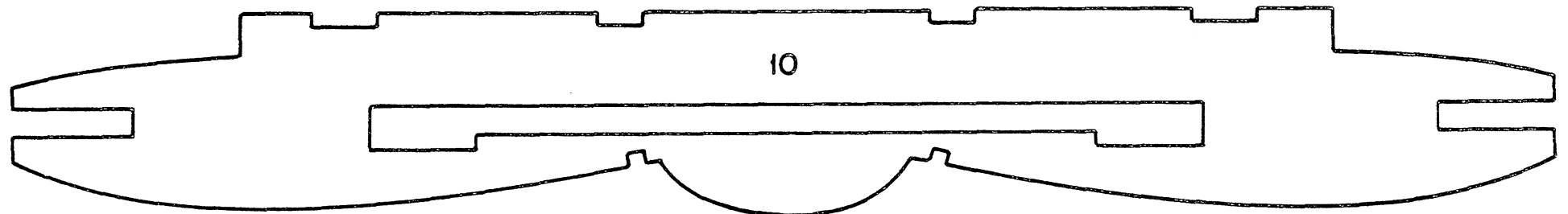
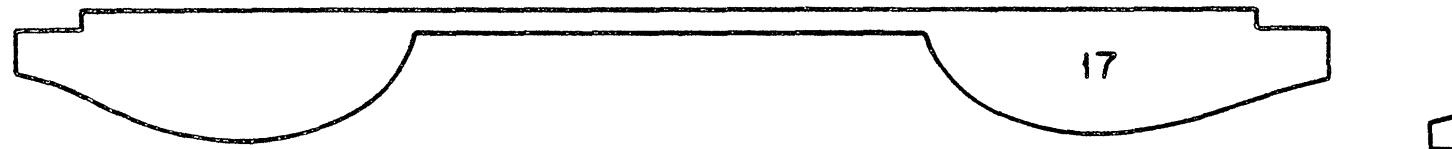

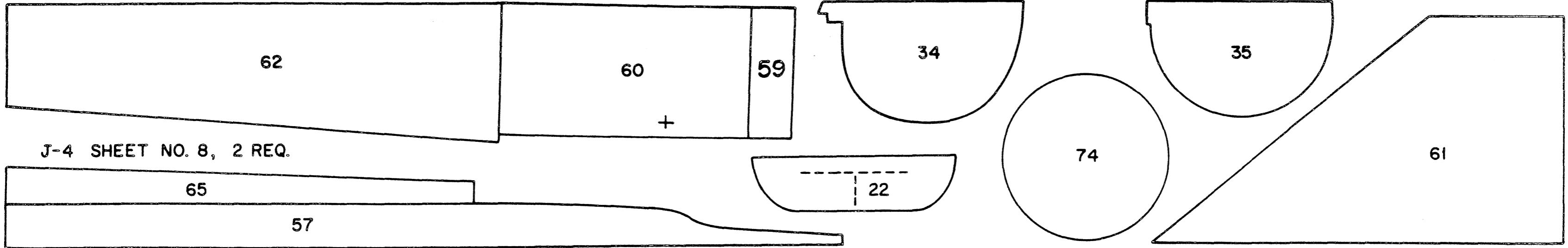

J-4 SHEET NO. 8, 2 REQ.



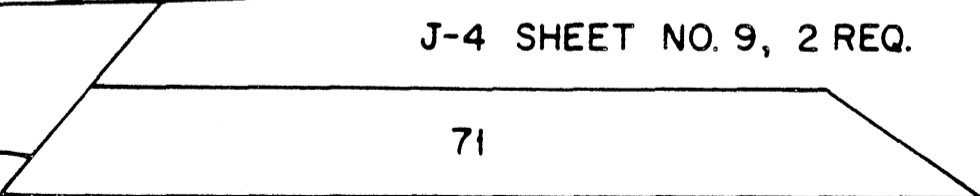
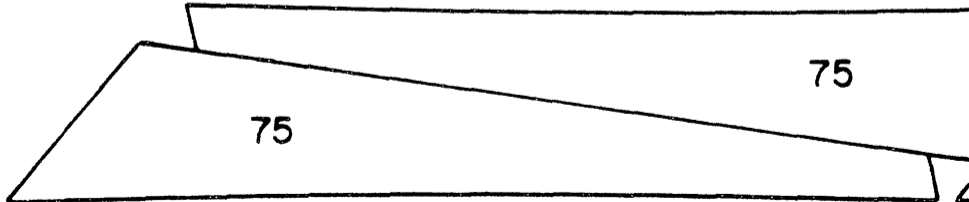
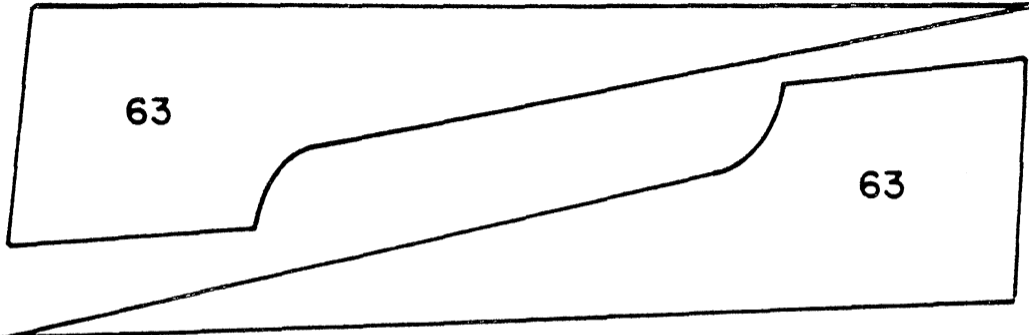
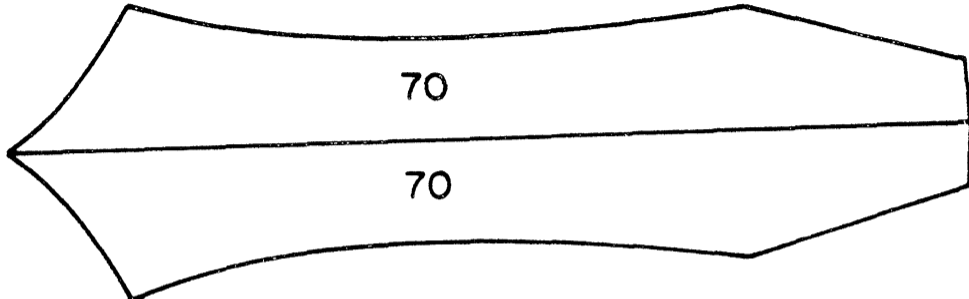

J-4 SHEET NO. 9, 2 REQ.

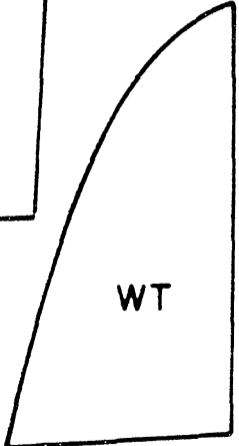

J-4 SHEET NO. 10

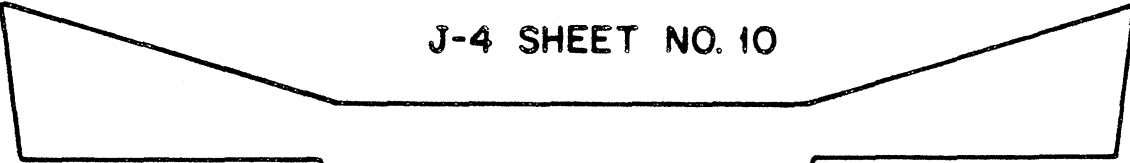

K3

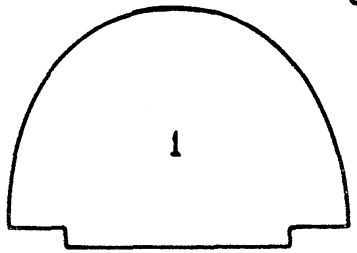
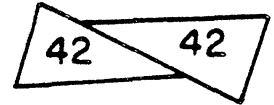
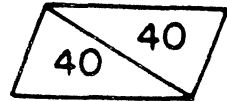

1

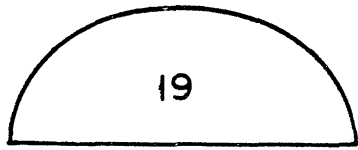

19

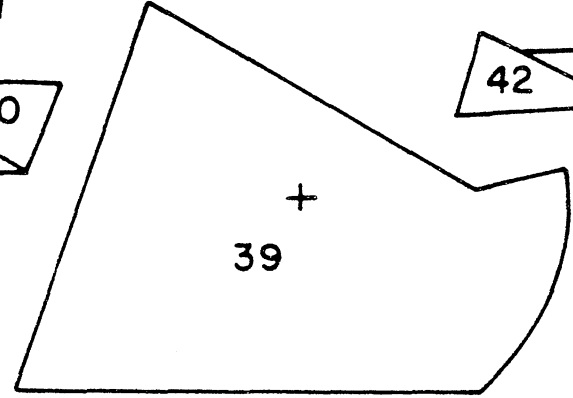

39

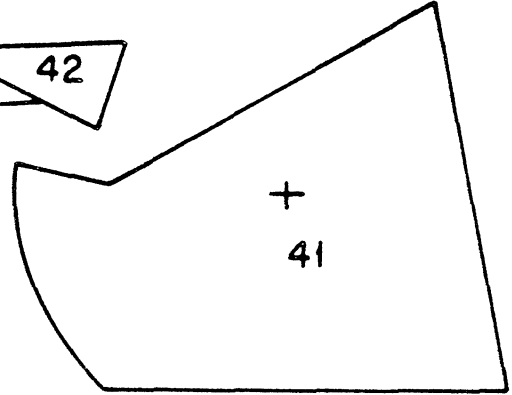

41

45

43

42

42

40

40

+

+

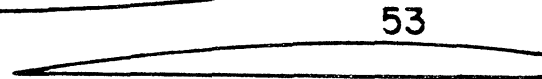
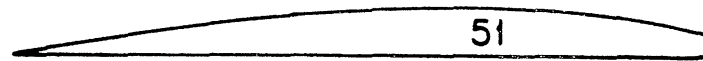
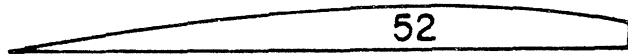
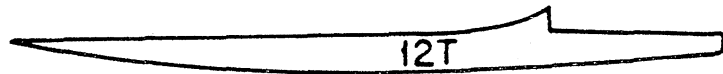
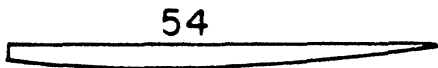
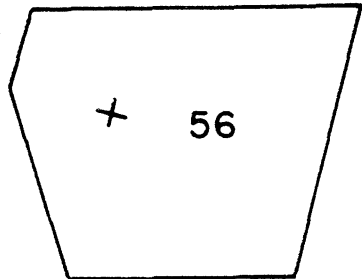

J-4 SHEET NO. 11, 2 REQ.

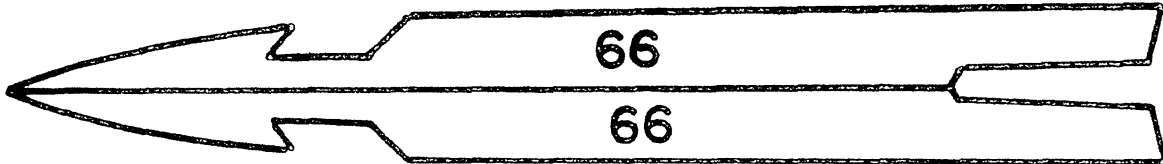

J-4 SHEET NO. 12