

FUSELAGE, SPLIT VIEW, TOP AND BOTTOM

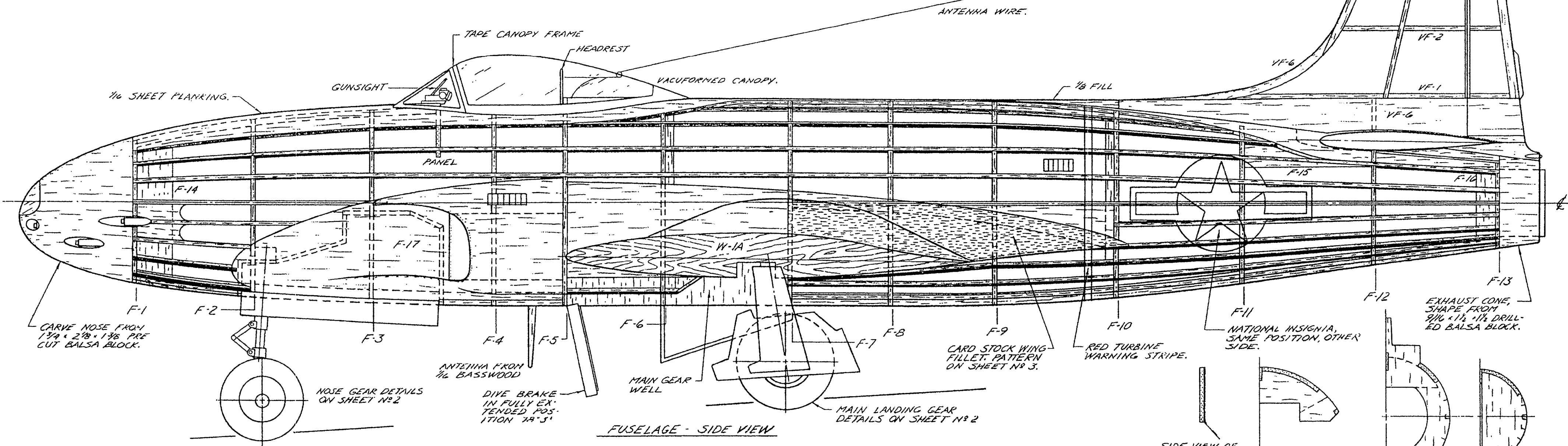

FUSELAGE - SIDE VIEW

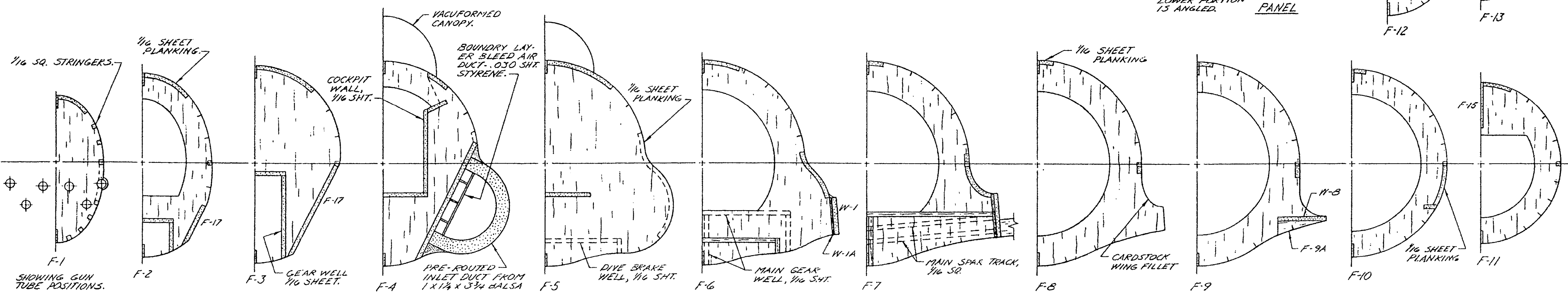

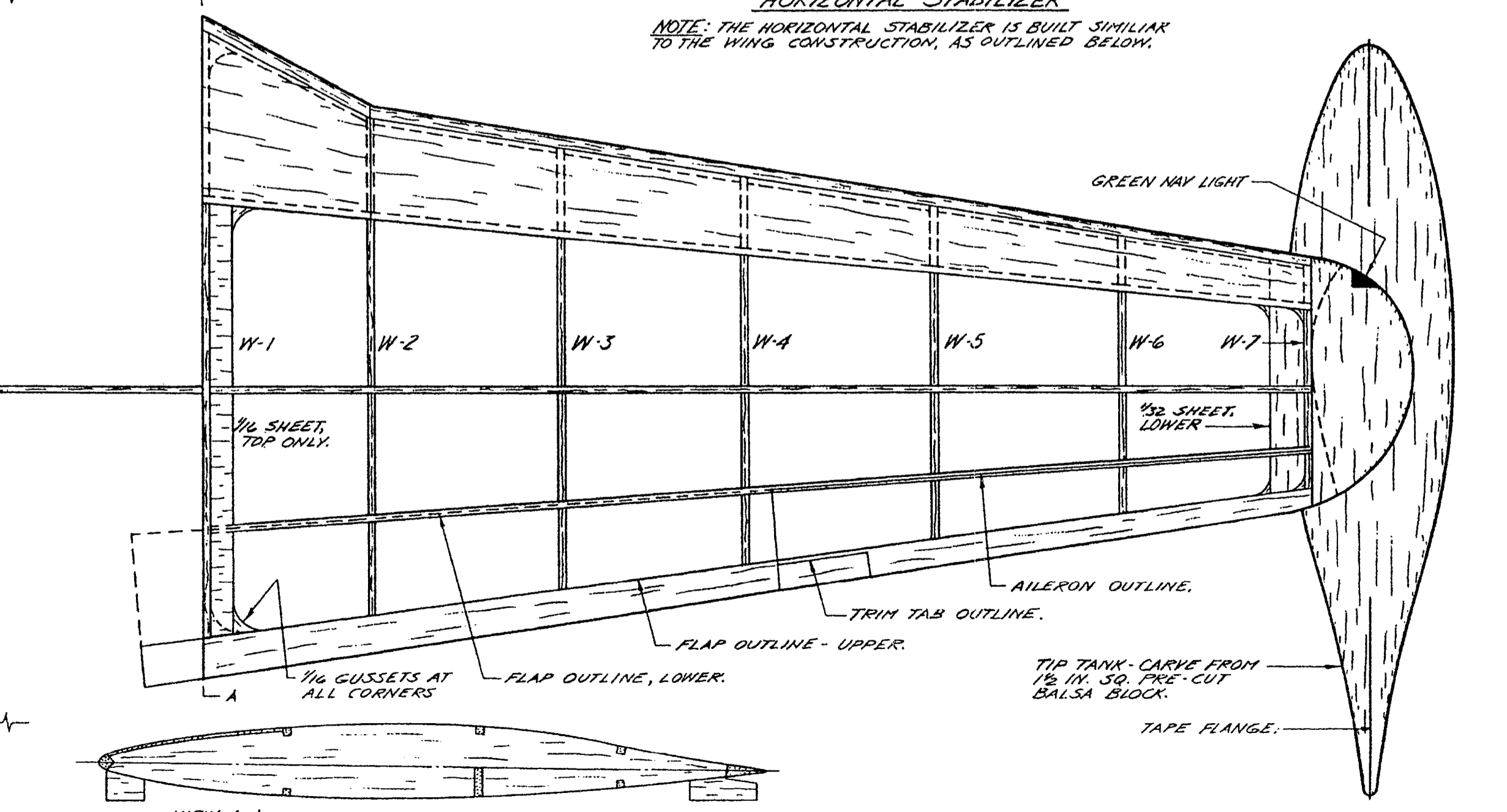
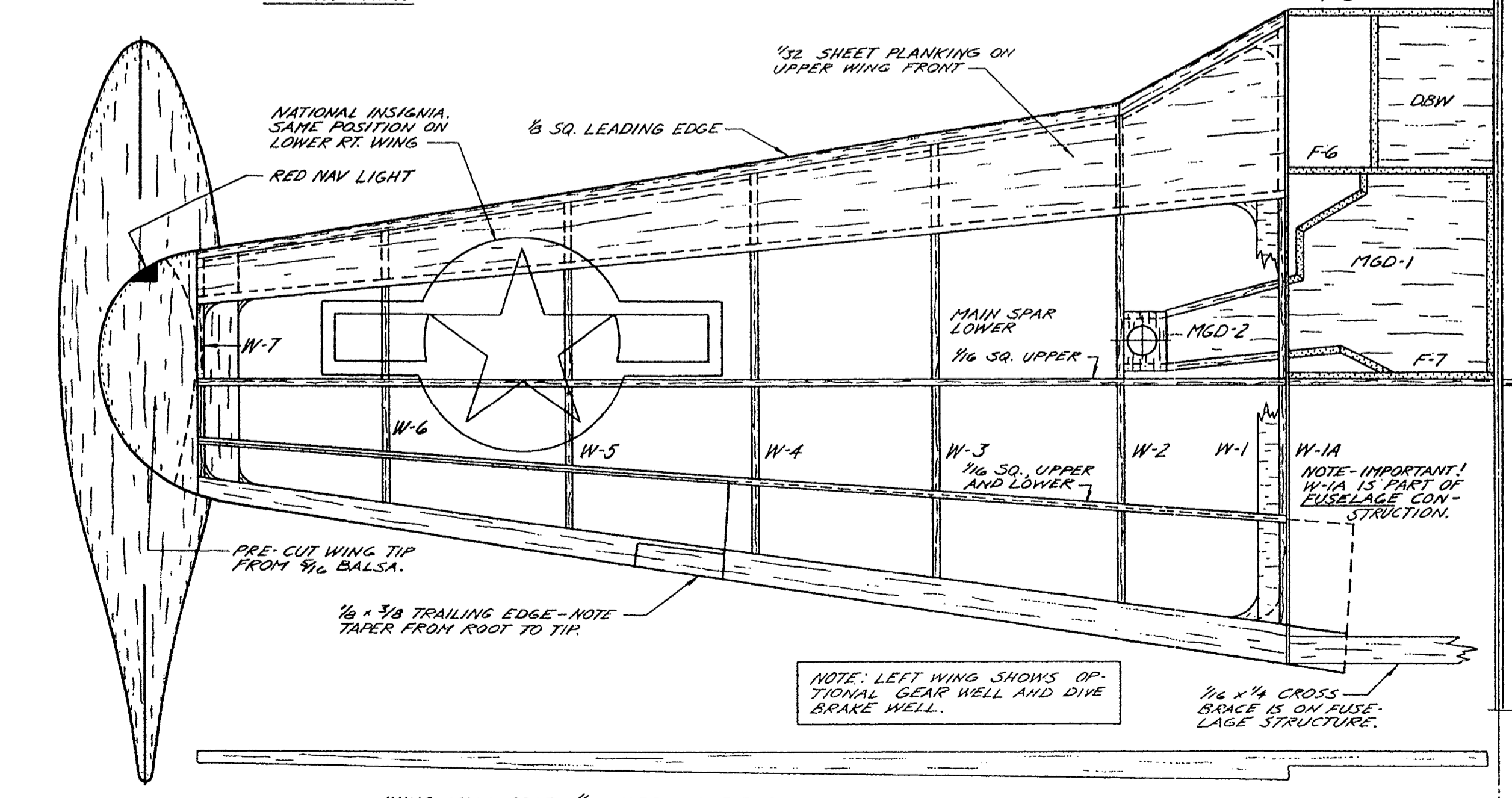
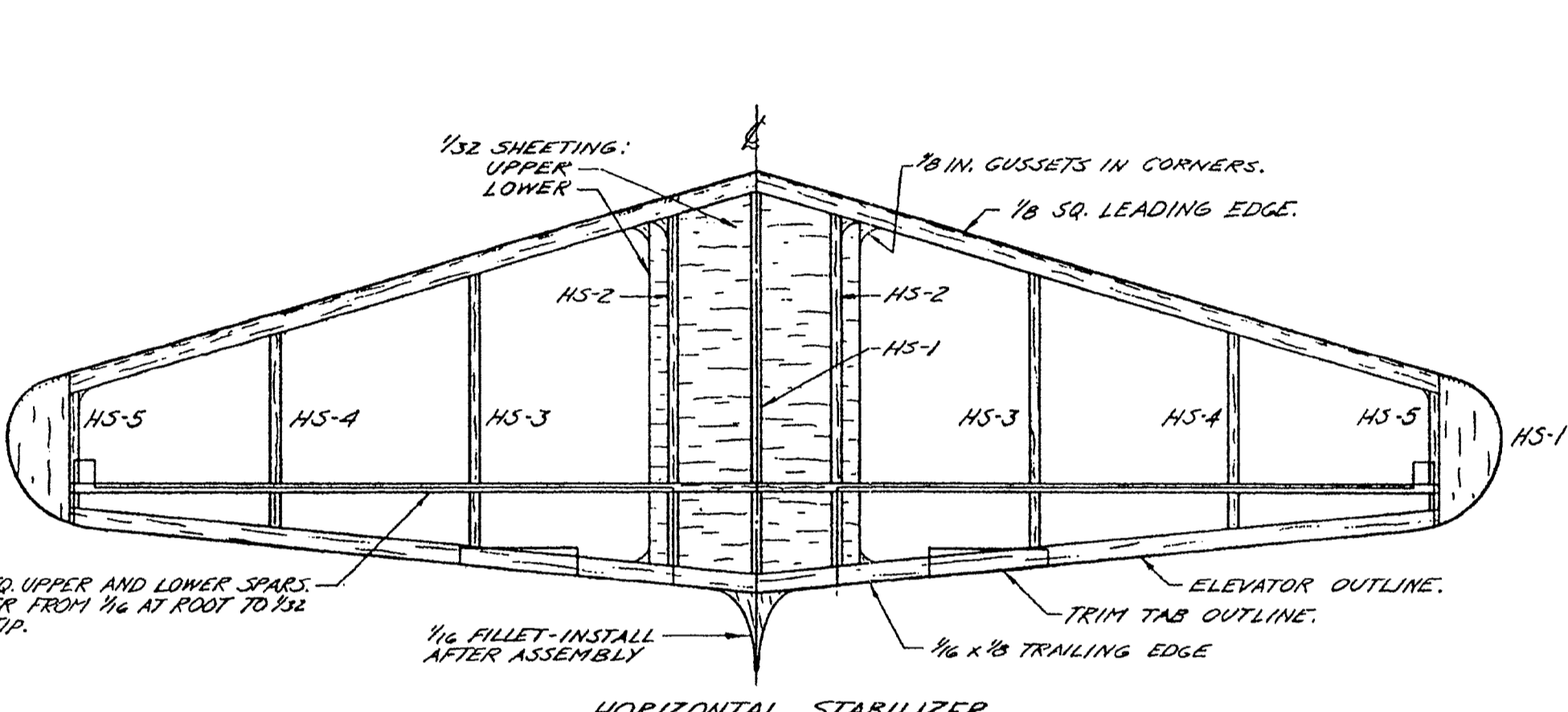
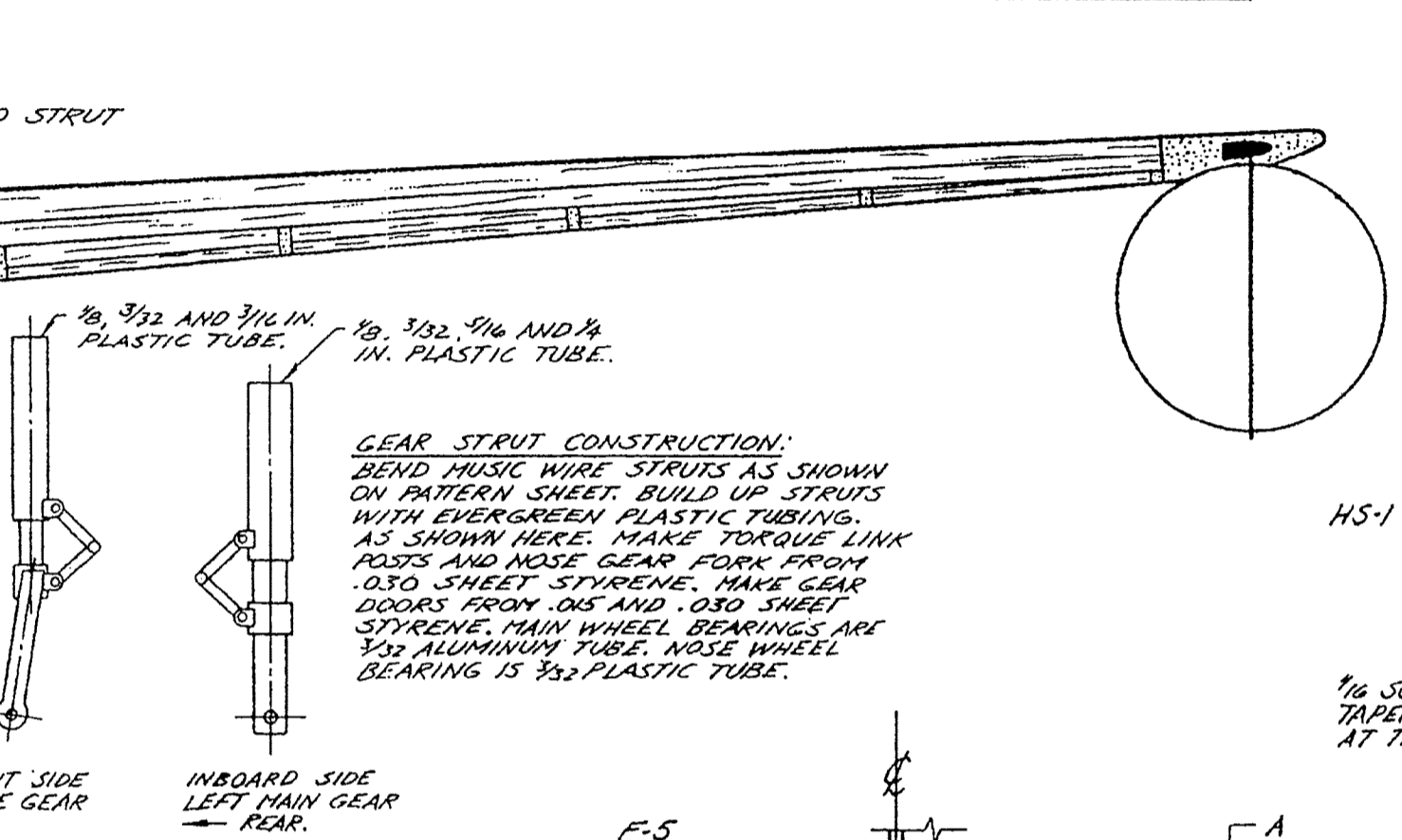
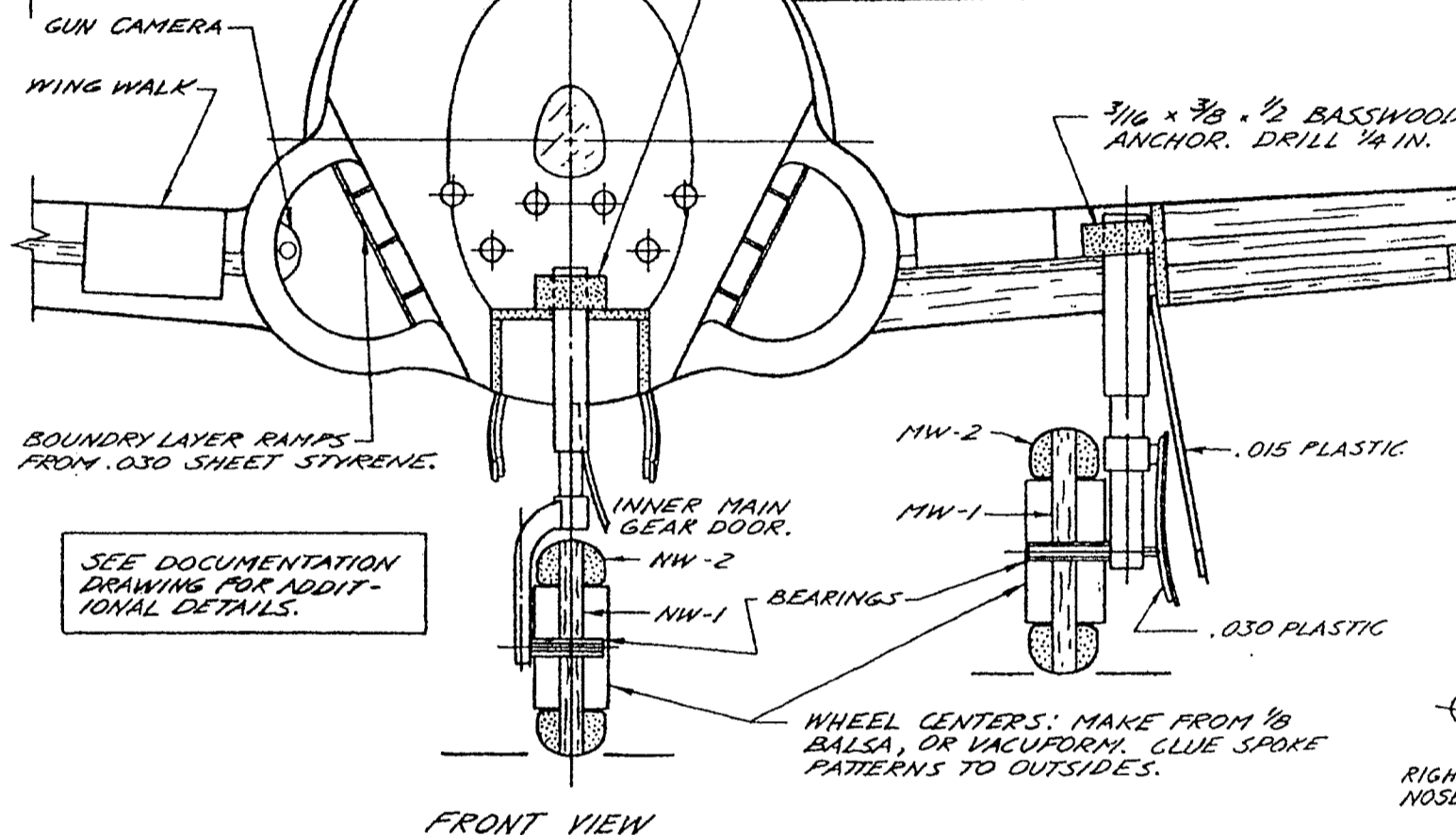
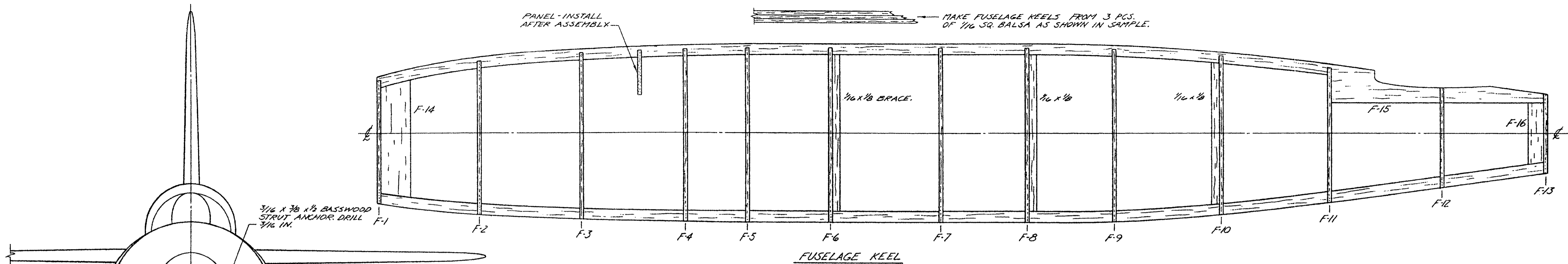

WING CONSTRUCTION: SET UP MAIN WING SPAR, W-1, W-2, AND W-7 TO BUILDING BOARD. INSTALL LEADING AND TRAILING EDGE PIECES. FIT W-3 THRU W-6 INTO PLACE. INSTALL TOP 1/16 CAP SPARS, AND LEADING EDGE PLANKING. REMOVE STRUCTURE, TRIM OFF POSTS, AND ATTACH LOWER CAP SPARS. SAND LEADING AND TRAILING EDGES TO PROFILE.

LOCKHEED P-80A SHOOTING STAR - SHEET 2.

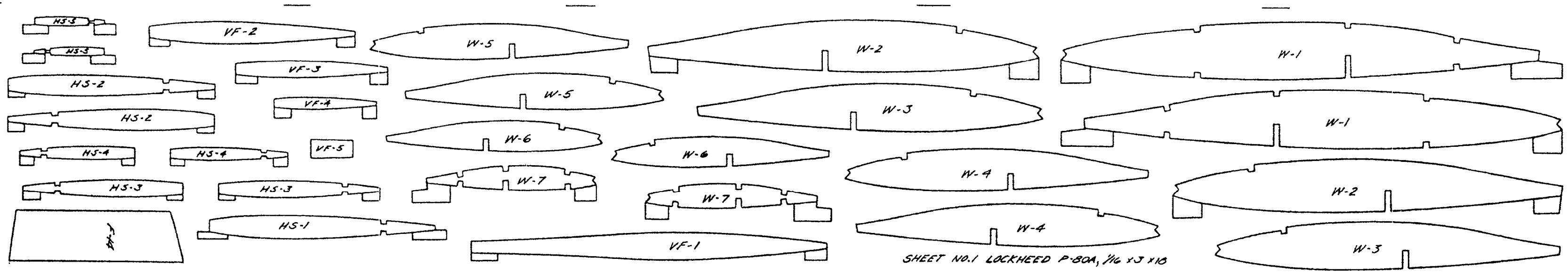

SHEET NO. 1 LOCKHEED P-80A, 1/16 X 3 X 18

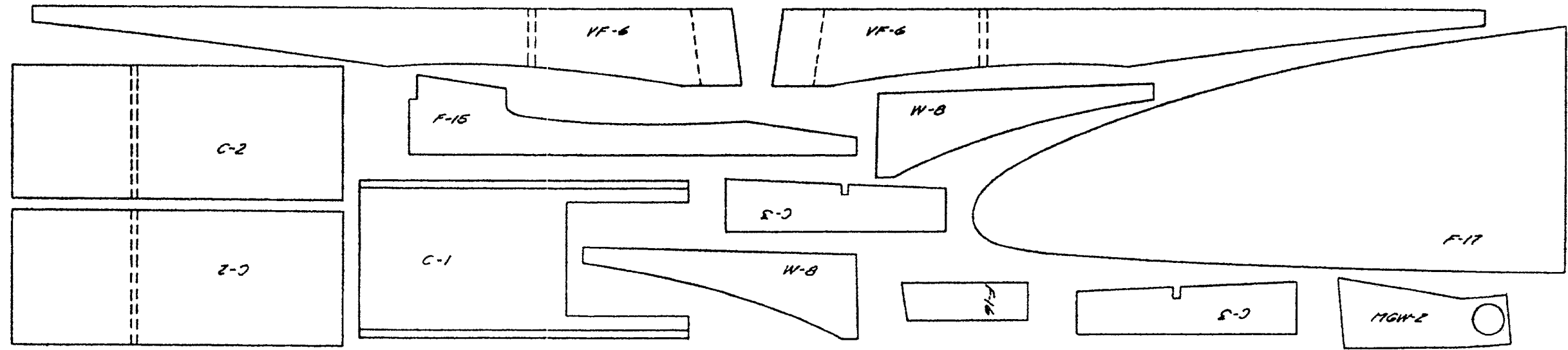

SHEET NO. 2, LOCKHEED P-80A, 1/16 X 3 X 18

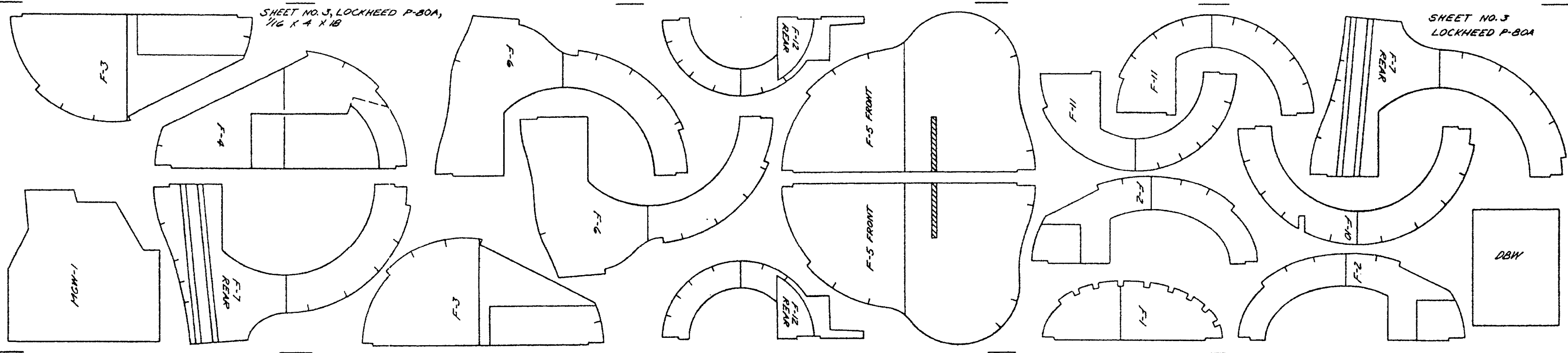

SHEET NO. 3, LOCKHEED P-80A, 1/16 X 4 X 18

SHEET NO. 3 LOCKHEED P-80A

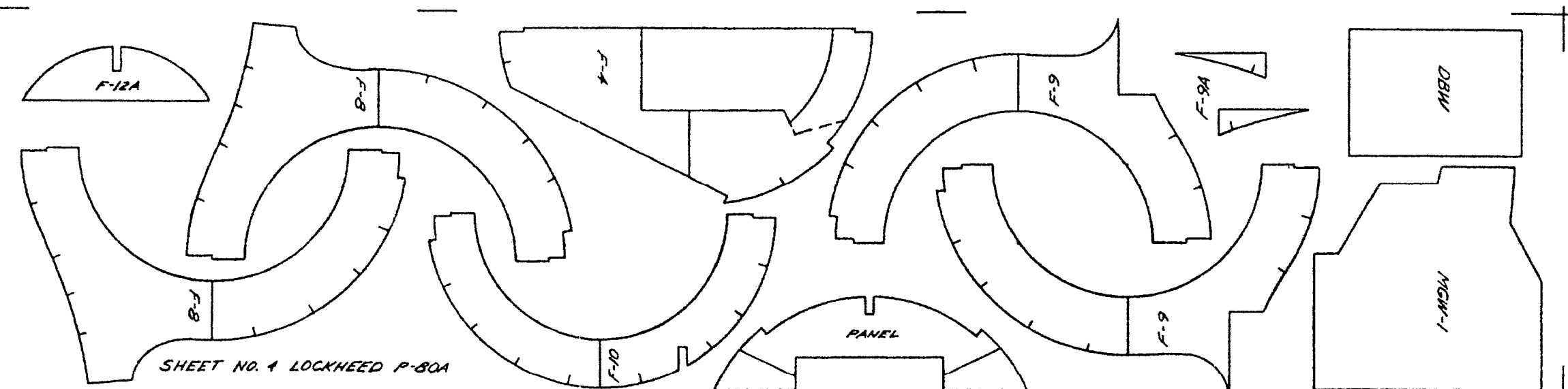

SHEET NO. 4 LOCKHEED P-80A

SHEET NO. 4, LOCKHEED P-80A, 1/16 X 3 X 12

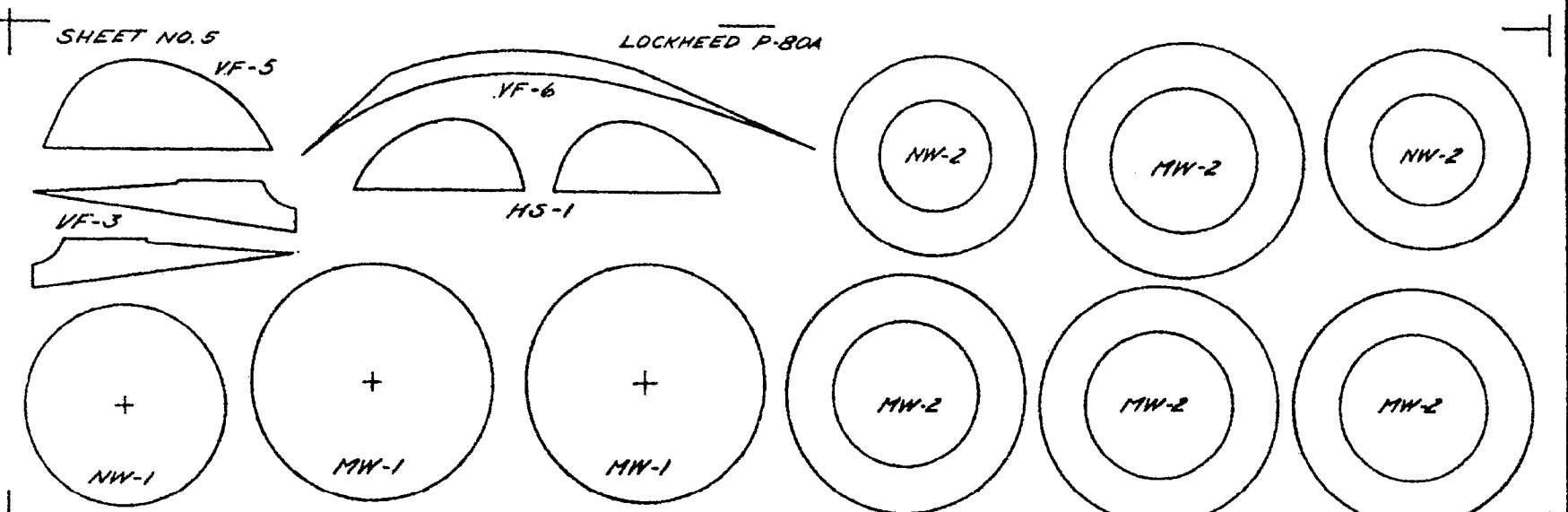

SHEET NO. 5 LOCKHEED P-80A

SHEET NO. 5, LOCKHEED P-80A, 1/8 X 3 X 9

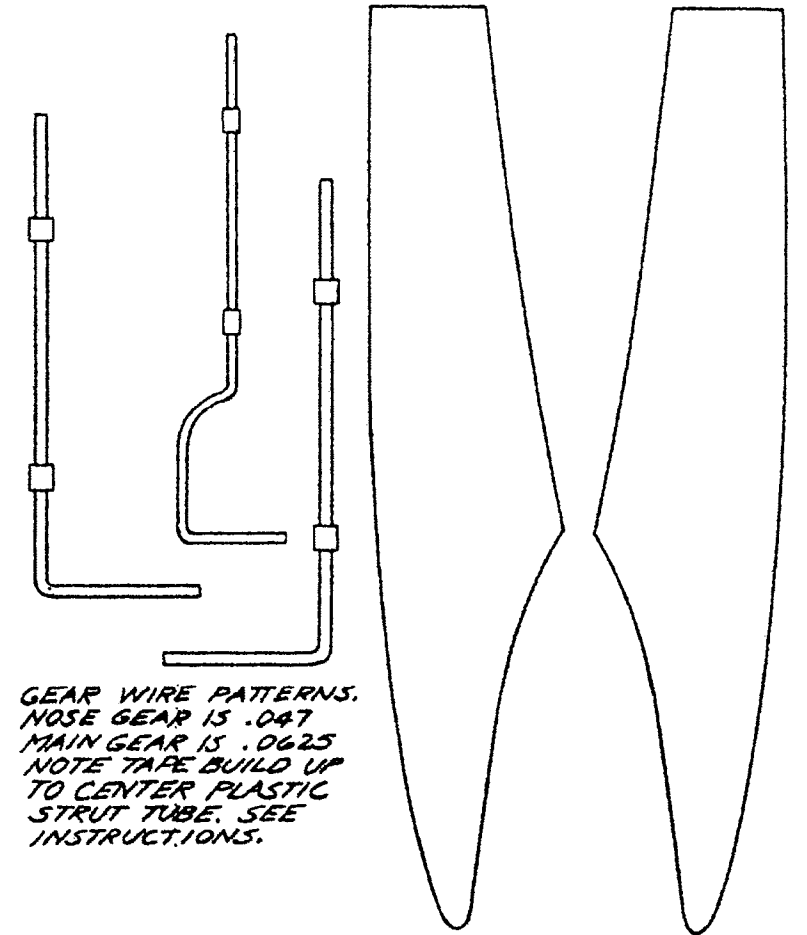

GEAR WIRE PATTERNS.
NOSE GEAR IS .087
MAIN GEAR IS .0625
NOTE TAPE BUILD UP
TO CENTER PLASTIC
STRUT TUBE. SEE
INSTRUCTIONS.

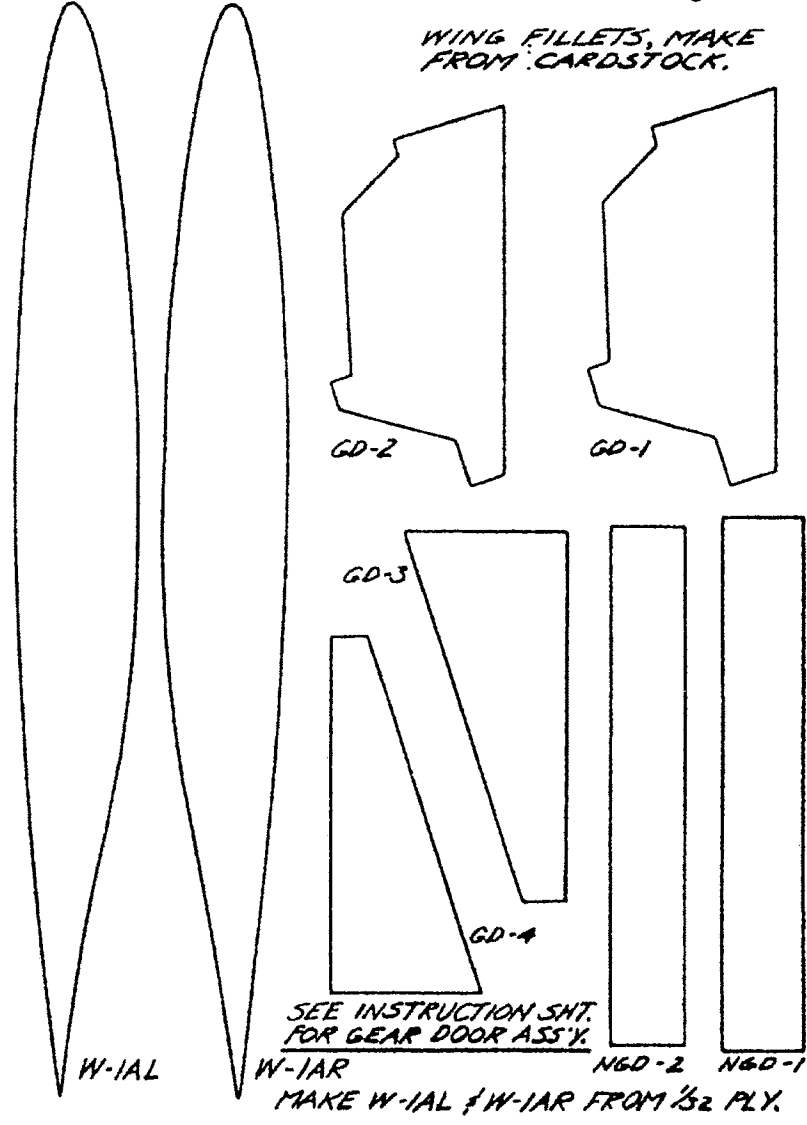

WING FILLETS, MAKE
FROM CARDSTOCK.

SEE INSTRUCTION SHT.
FOR GEAR DOOR ASS'Y.
MAKE W-1A1 & W-1A2 FROM 1/32 PLY.