

IMP SABRE . SHEET NO 1 .  $\frac{1}{16}$ " x 3" x 12

1 OFF.

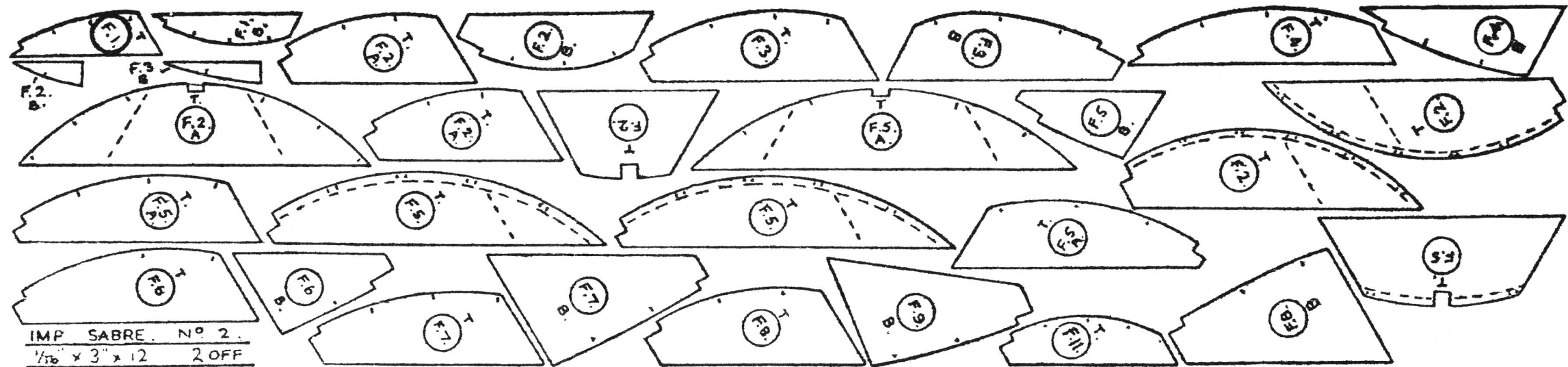

IMP SABRE. N° 2.  
1/16" x 3" x 12 2 OFF

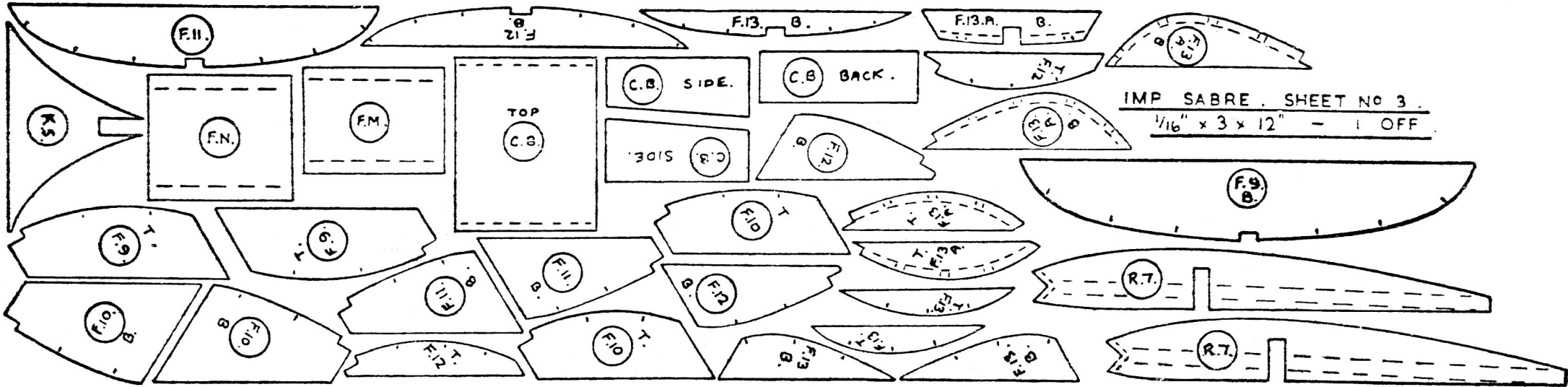

IMP SABRE . SHEET NO 3 .  
 $\frac{1}{16}'' \times 3 \times 12''$  - 1 OFF

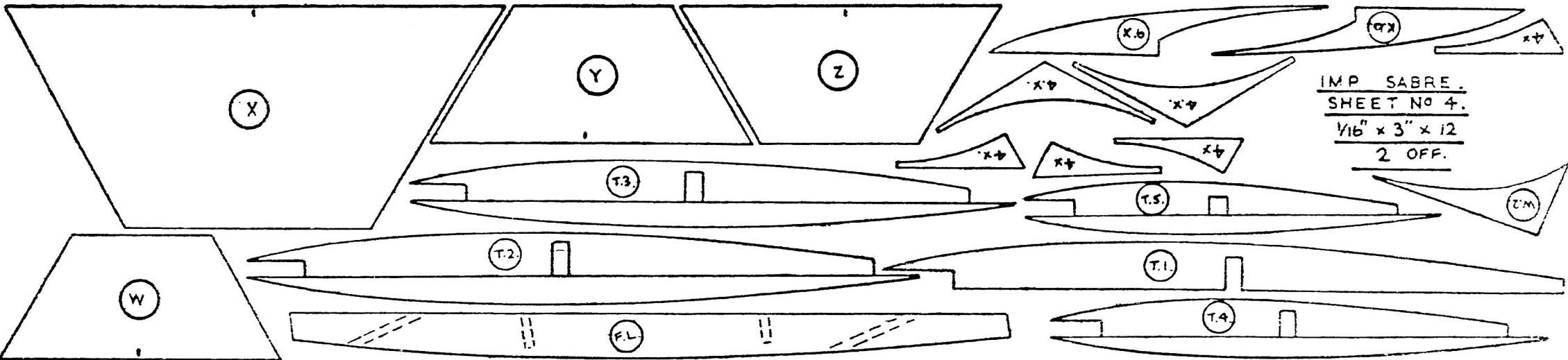

IMP SABRE.  
SHEET NO 4.  
 $\frac{1}{16}'' \times 3'' \times 12$   
2 OFF.

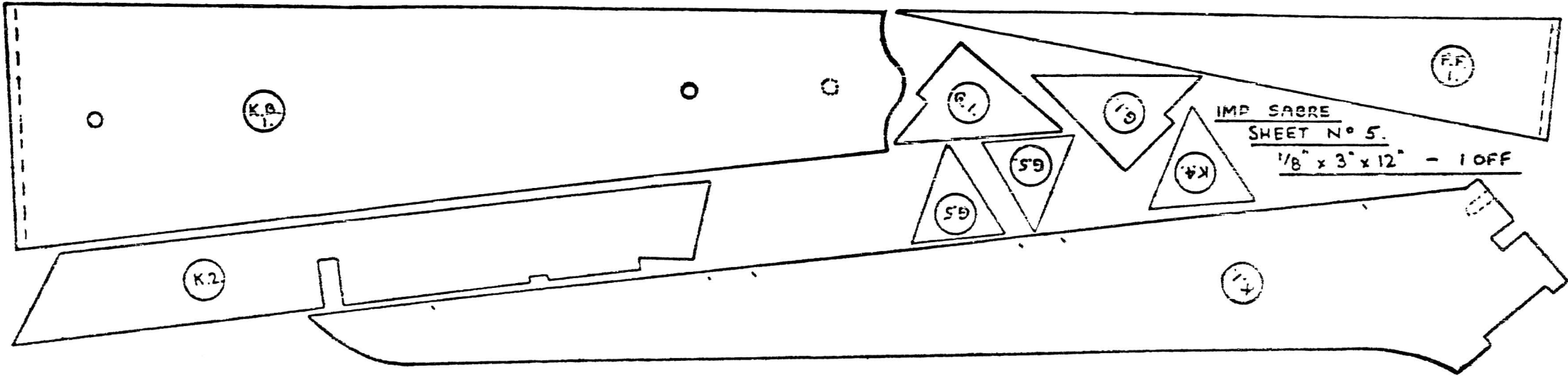

IMP SABRE  
SHEET N° 5.  
1/8" x 3" x 12" - 1 OFF

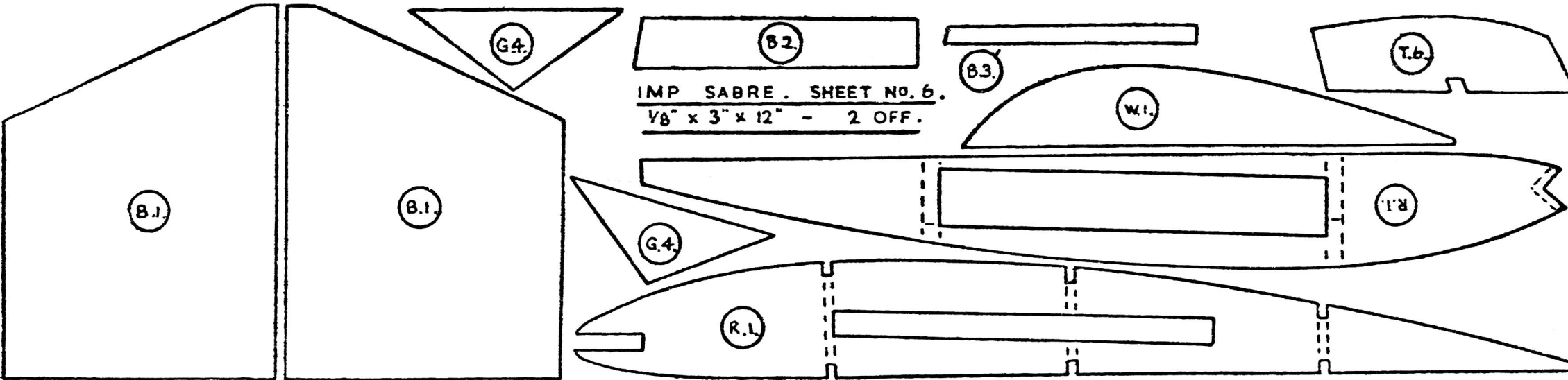

IMP SABRE . SHEET NO. 6.  
1/8" x 3" x 12" - 2 OFF.

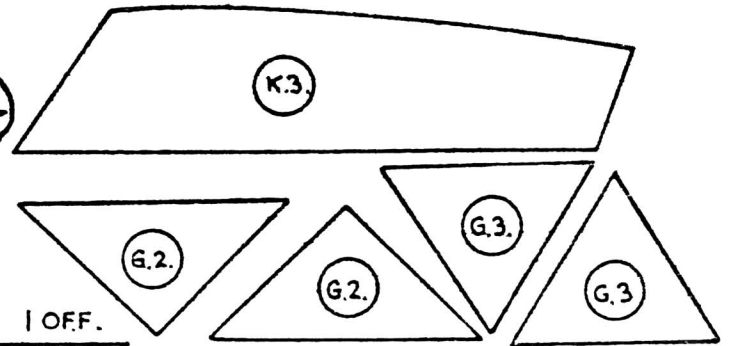
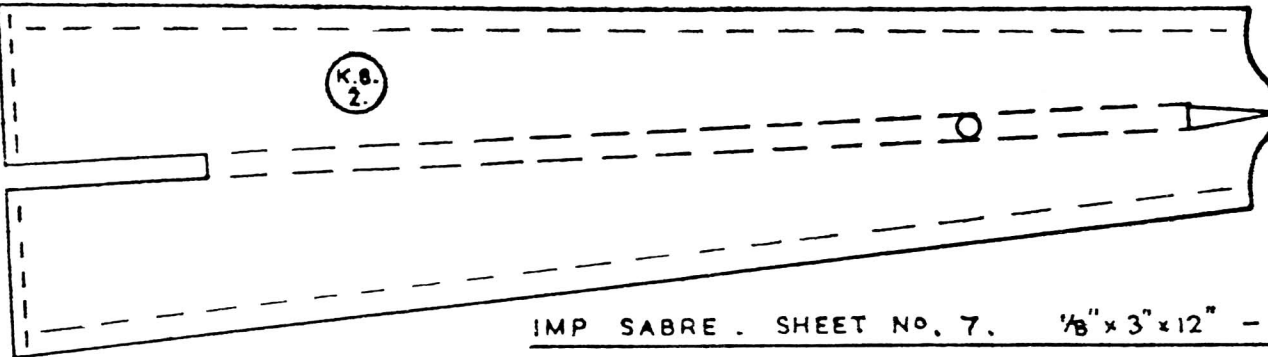

IMP SABRE . SHEET NO. 7.  $\frac{1}{8}$ " x 3" x 12" - 1 OFF.

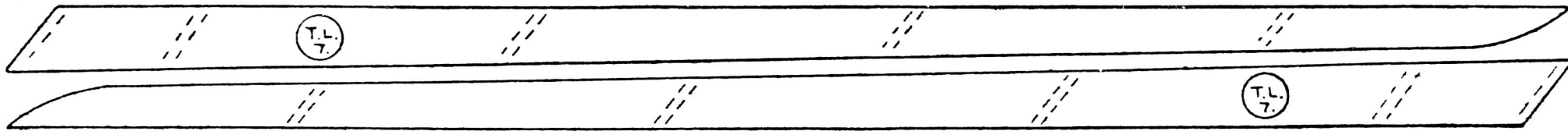

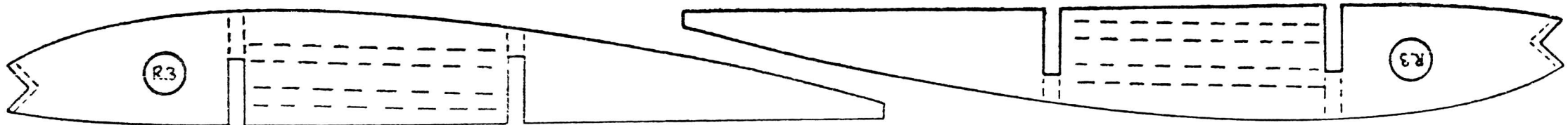

IMP SABRE.  
SHEET N° 8  
 $\frac{1}{16}$  x 3" x 12"  
1 OFF.

