

STRINGERS: 1/20"

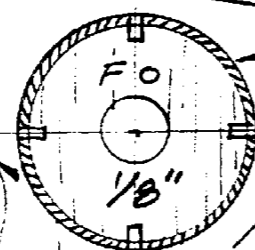

1/32" SOFT SHEET Balsa

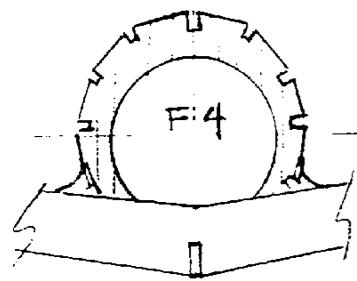
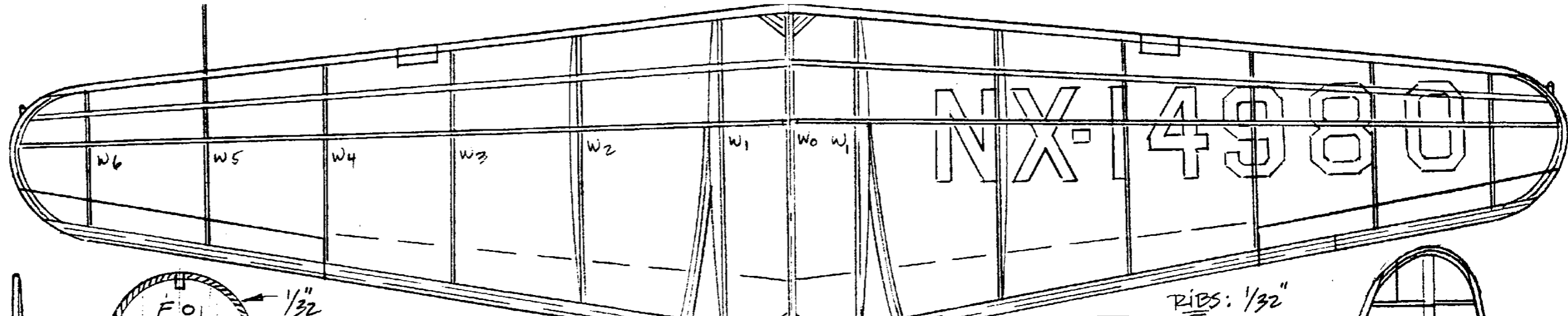
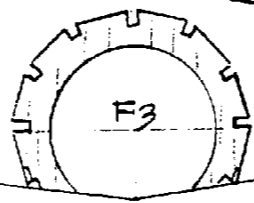
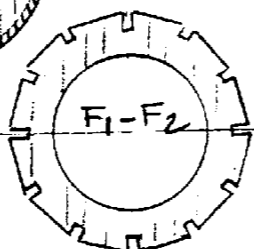

F0 F1 F2 F3 F5

RIBS: 1/32"

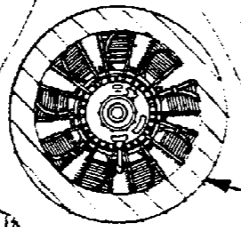
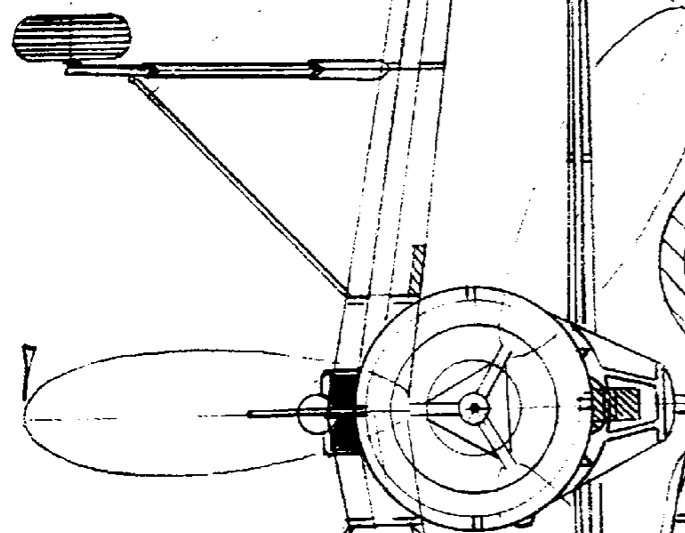
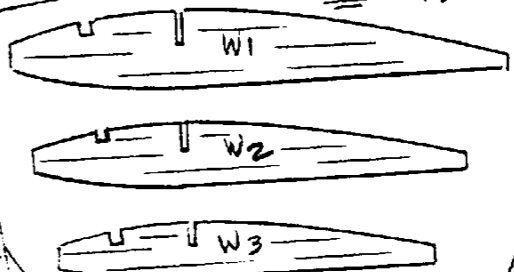

COWL RING

ALL BULKHEADS 1/32"

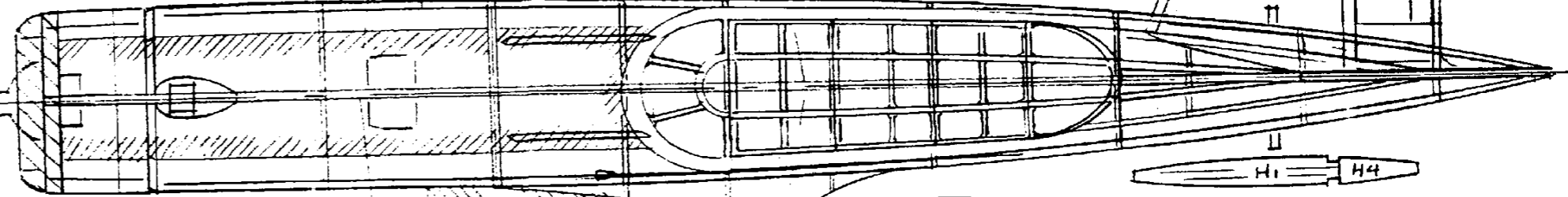

BLACK

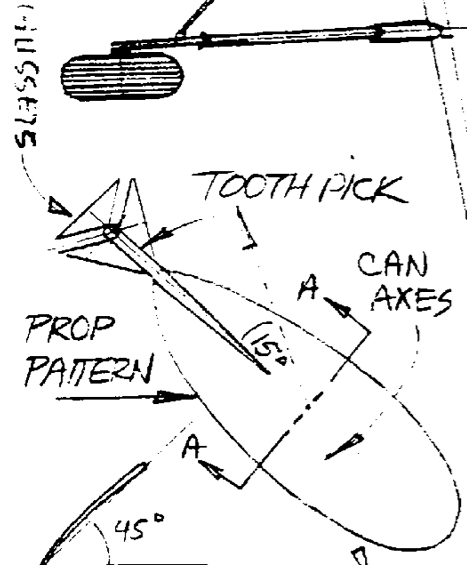
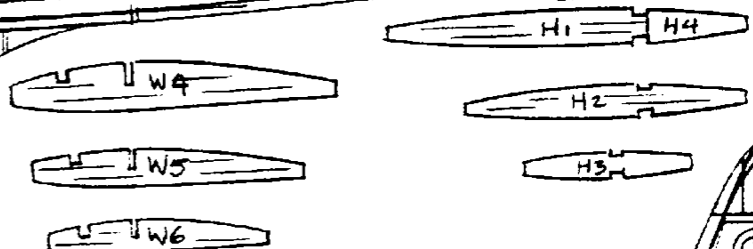

PROP PATTERN
TOOTH PICK
CAN AXES
A
45°
A-A

REF: VULTEE AIRCRAFT 1932-47 JONATHAN

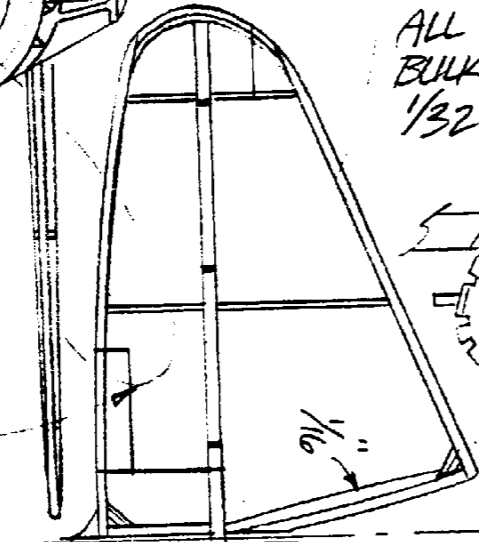

TIP DIHEDRAL: 1/16" EACH SIDE

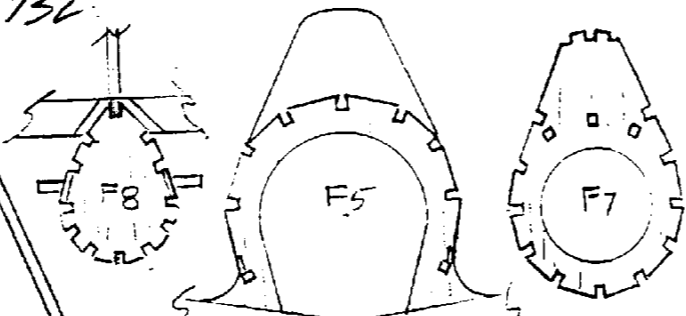

RED



BLACK

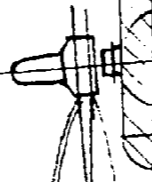

FOAM

PAPER SLEEVE

TONGUE

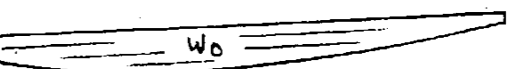
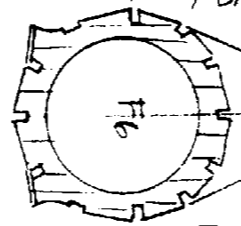

F5 F6 F7 F8

FOAM

COLOR SCHEME:
ALL SILVER BLACK
ANTI GLARE & LETTERING
RED COWL RING

VULTEE V-11T TEST
SHIP P-NUT SCALE
BY PRES BRUNING
15 JAN '95