

SPAR TAPER  $\frac{3}{16}$  TO  $\frac{1}{8}$

$\frac{3}{32}$  SQ  $\frac{1}{32}$

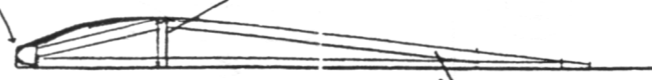

TYP RIB SECTION  $\frac{1}{20}$  SQ

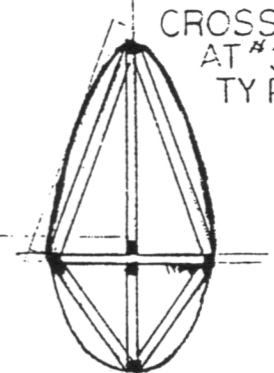

CROSS SEC.  
AT #3  
TYPE

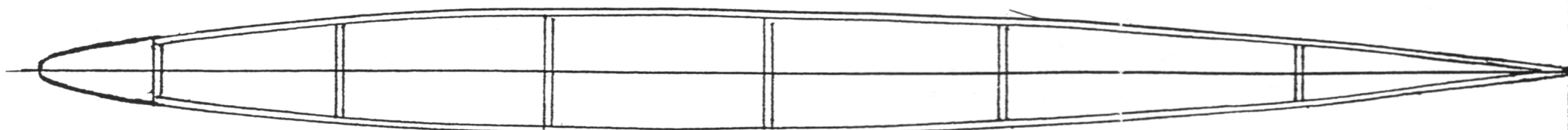
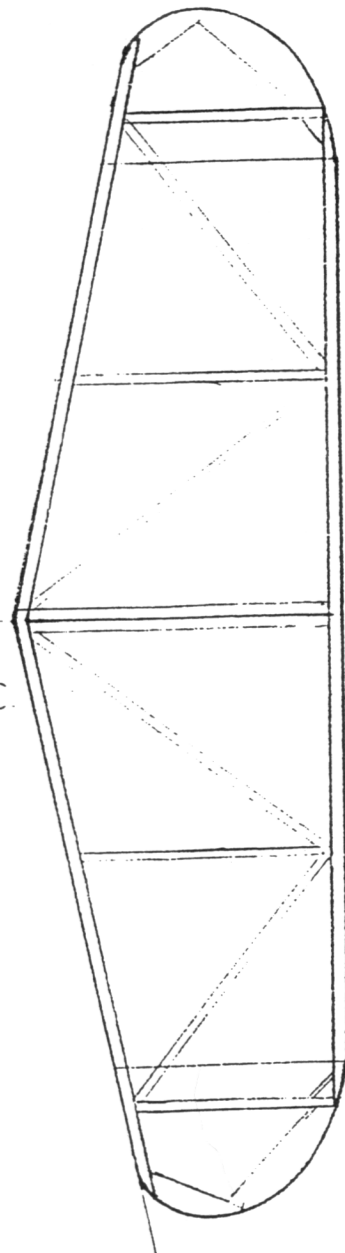

N1 N2 N3 N4

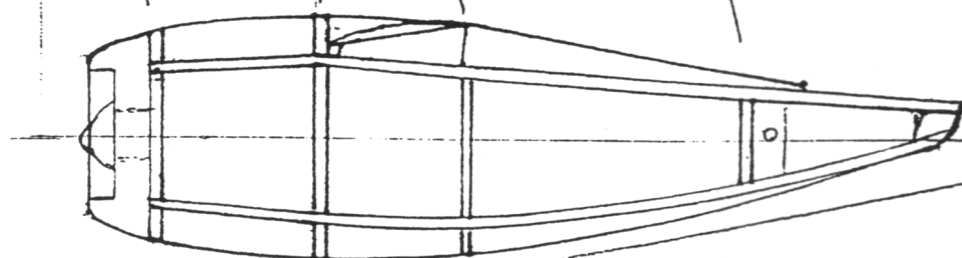

2 LAMS  $\frac{1}{20} \times \frac{1}{32}$   
CONTINUOUS STRIP FROM  
S.A.#3 TO BOTTOM OF  
RUDDER

WING MOUNT BUILD INTO  
UPPER HALF OF FUSELAGE

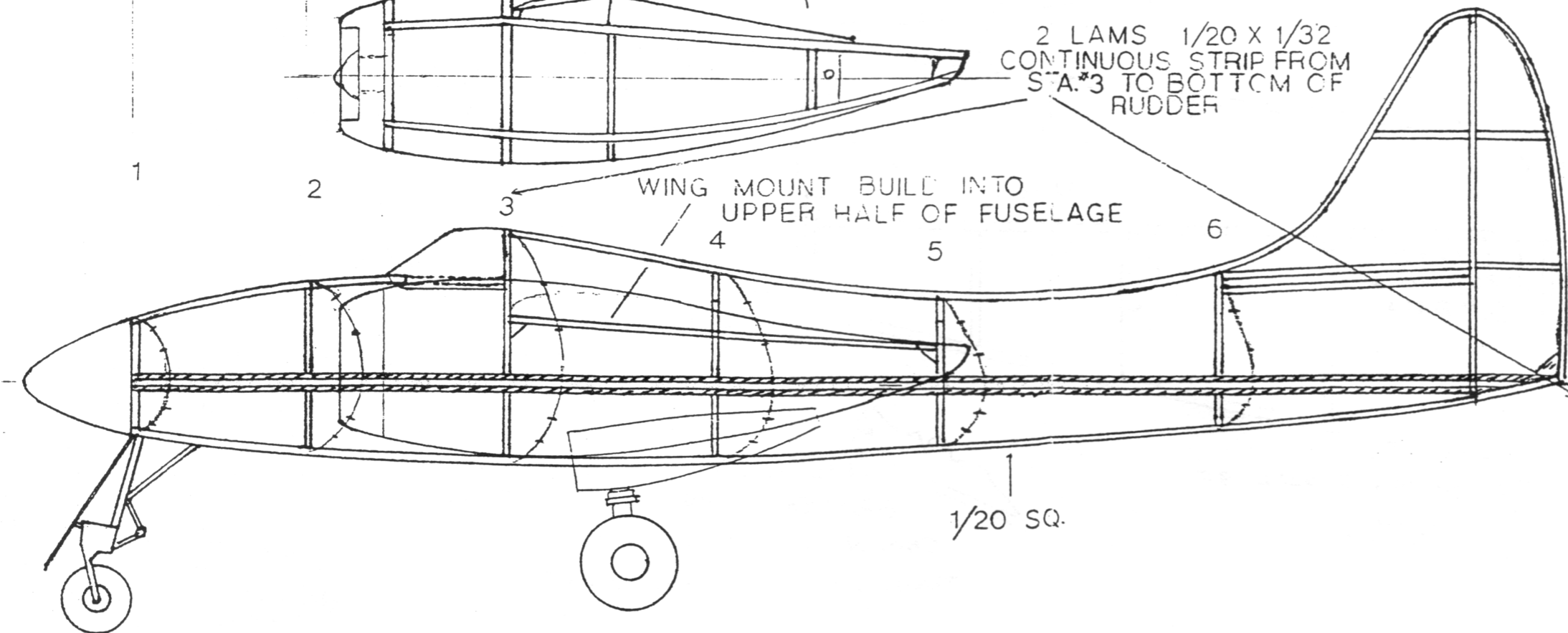

1

2

3

4

5

6

$\frac{1}{20}$  SQ.

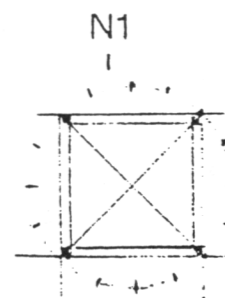

N1

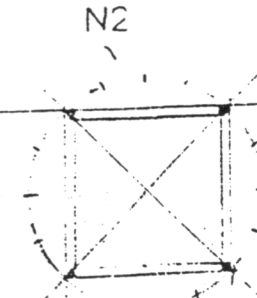

N2

GRUMMAN F7F-1 "TIGERCAT"  
PEANUT SCALE BY  
DICK HOWARD