

Thomas

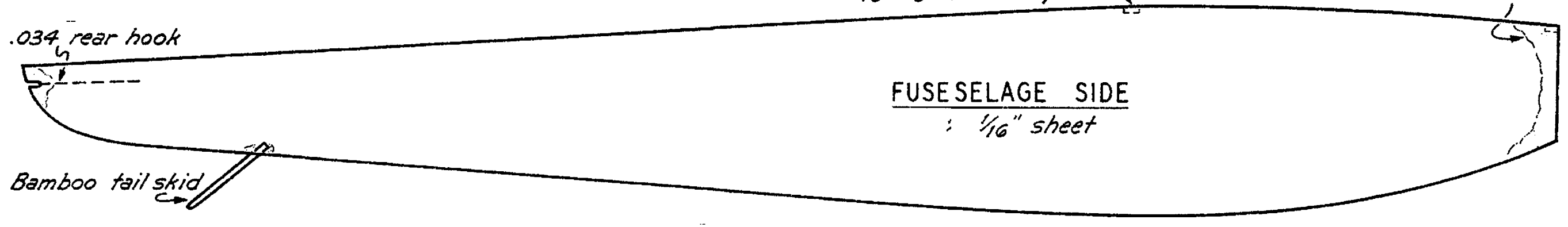

Cement skin

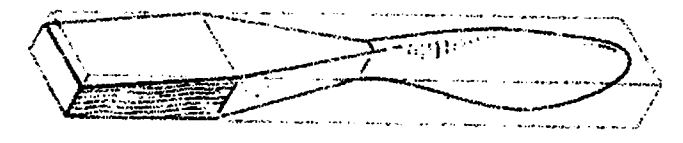
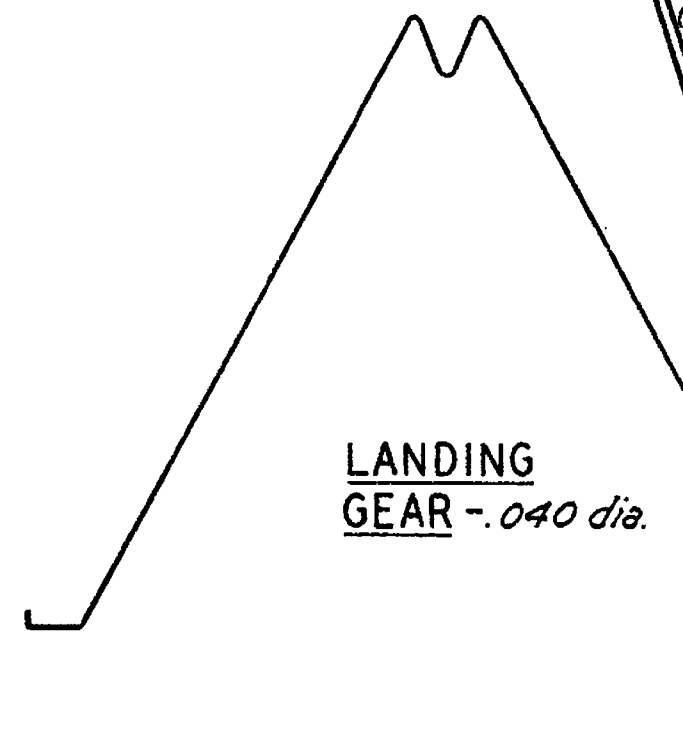
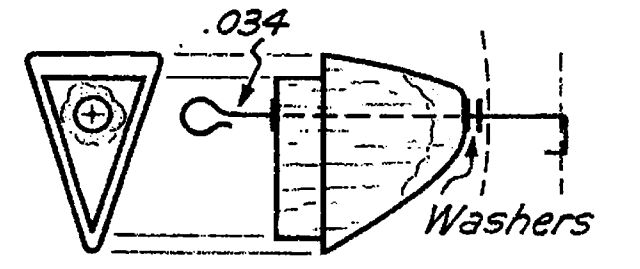
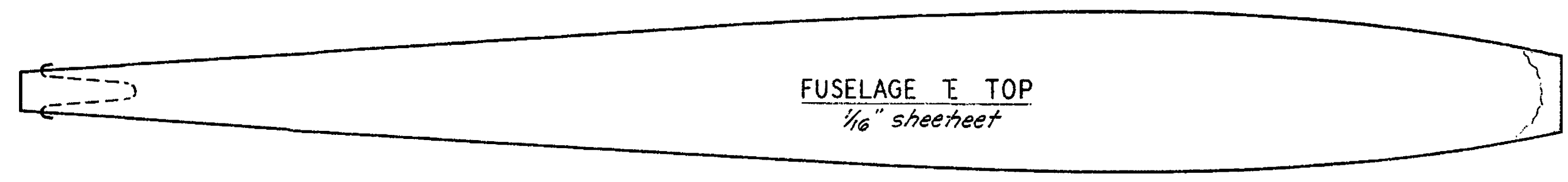

Louis Garami
Commando

Commando

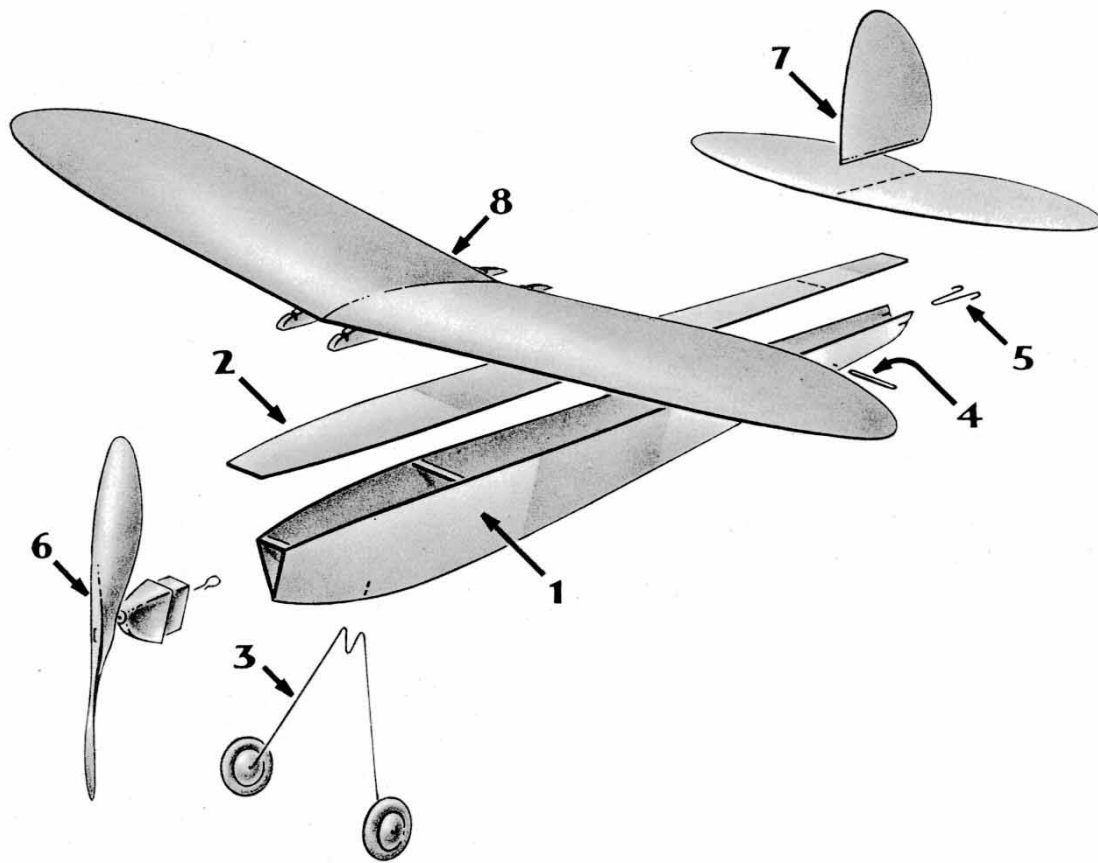

Who said sheet-balsa models always look clumsy? This one's the exception, chum. No balsa? Try bristol board.

BY LOUIS GARAMI

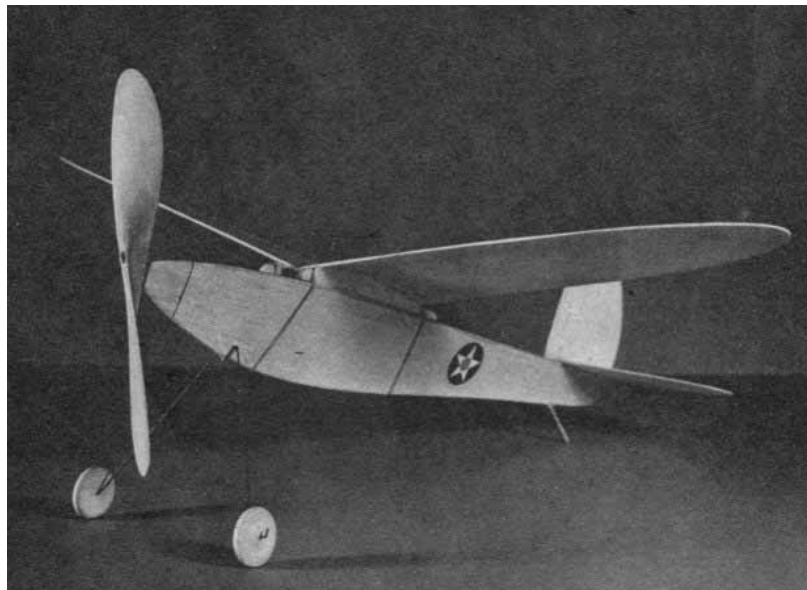

The modeler usually feels that he is out of the beginner's class upon completion of his first "fuselage" model. And rightly so, for he can expect performance and more realism in return for his efforts. Here is the ideal first fuselage model for beginners -- one that will also please advanced builders.

For even weight distribution it is important to carefully select sheet balsa of the same even, light texture. Avoid the use of hard balsa for this model. Using three-inch-width sheet, cut wing halves, tail group, and fuselage sides and top from the full-size patterns included in the plans. Lightly sand the edges, smoothing the curves. Fuselage sides and wing halves may be sanded in pairs.

Make a sanding block of medium sandpaper and by placing the wing halves and tail group parts on a flat surface, taper the 1/16" sheet to 1/32" thickness toward the tips. Cement 1/16" square strips to the rudder base for additional support when it is cemented to the stabilizer.

Carve the nose block of soft balsa to exact

dimensions shown on the plans. Sandpaper it lightly and smear cement around the front for reinforcement.

Cut two wing formers from 1/8" sheet. Bend landing gear, propeller shaft and rear hook. Obtain a ready-carved seven-inch propeller from your model dealer or whittle your own from the block shown on the plans. Strip a small splint of cane or bamboo for a tail skid.

Now that all parts are prepared, the model may be easily completed by referring to the assembly sketch.

Equip the model with four strands of 1/8" flat rubber with little or no slack so that the nose plug and rear hook will stay snugly in place. Loop small rubber bands around the fuselage and over the wing former notches. Shift the wing along the fuselage until the model hangs level when held by the wing tips. Test-glide the model over a grassy spot, shifting the wing until the model glides smoothly. Limit first flights to few turns; final adjustments are made before winding to capacity. Let us know how she flies !

*Scanned From 1942
Air Trails Annual*