

# S&T PILATUS PC-6 PORTER NoCaI

DRAWN BY TOM AKERY 5 APRIL 2017 FROM 3 VIEW FROM THE NET

16" WINGSPAN 11 3/16" LENGTH for [stickandtissue.com](http://stickandtissue.com) **NOT FOR RESALE**

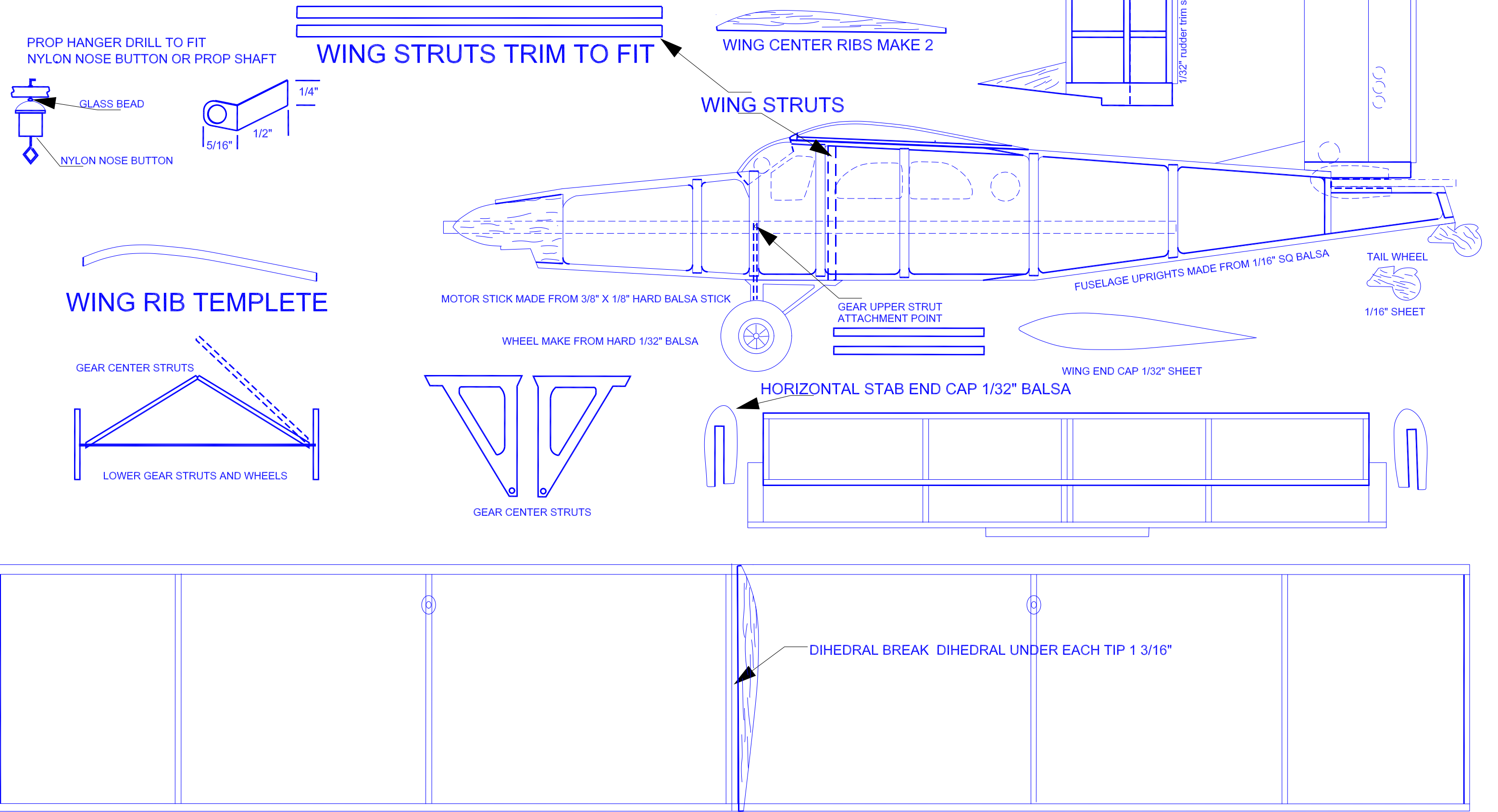

PROP HANGER DRILL TO FIT  
NYLON NOSE BUTTON OR PROP SHAFT

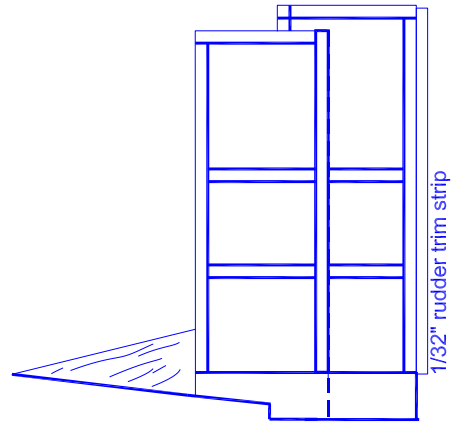
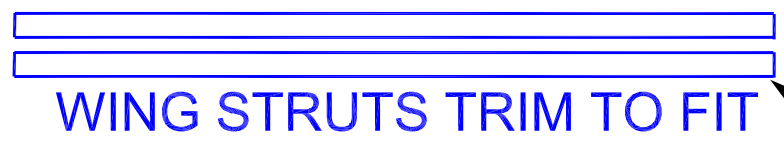
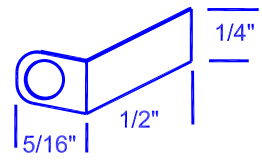
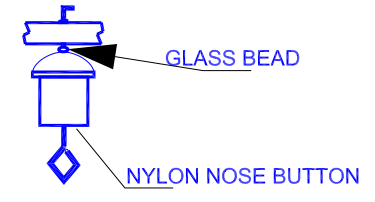

WING STRUTS

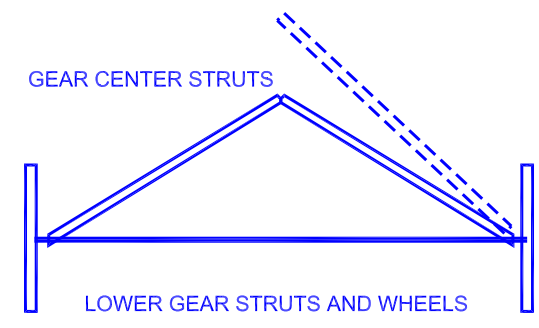
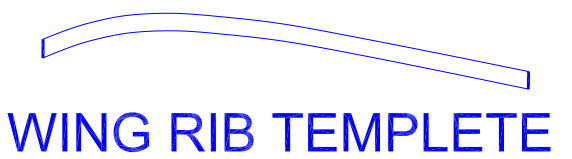

MOTOR STICK MADE FROM 3/8" X 1/8" HARD BALSA STICK  
WHEEL MAKE FROM HARD 1/32" BALSA

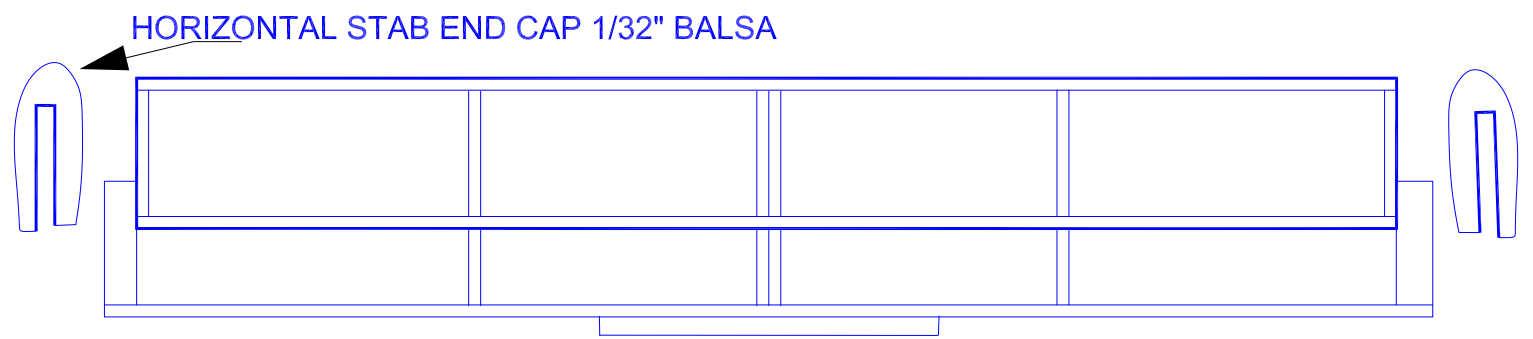
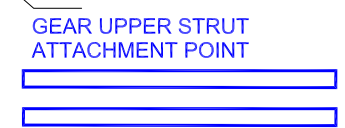
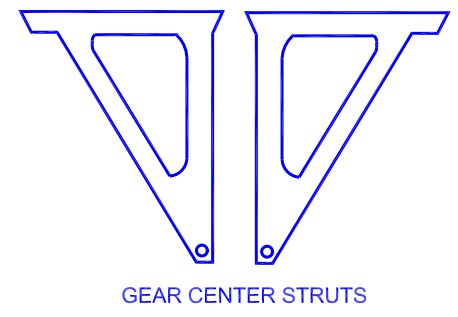

DIHEDRAL BREAK DIHEDRAL UNDER EACH TIP 1 3/16"

