

THE *Improved* BARNES SNORTER

TYPE - BF-4D FICTION FLYER 20" DRAWN BY TOM AKERY 31AUG2024

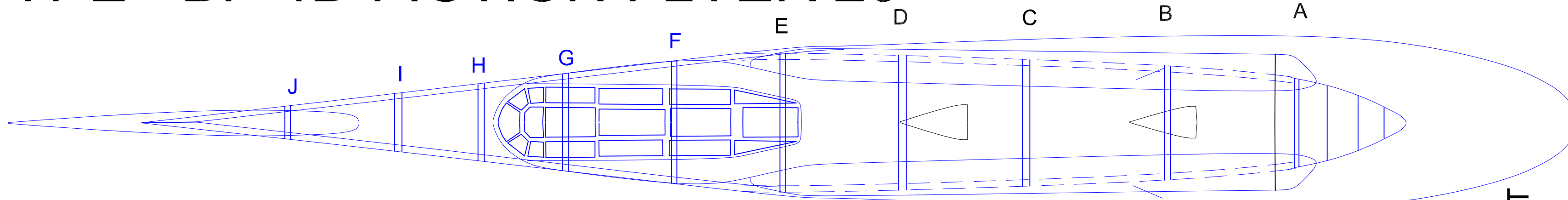

RUBBER POWERED - CAN BE MADE WITH CONTRA-ROTATING PROPS OR SINGLE

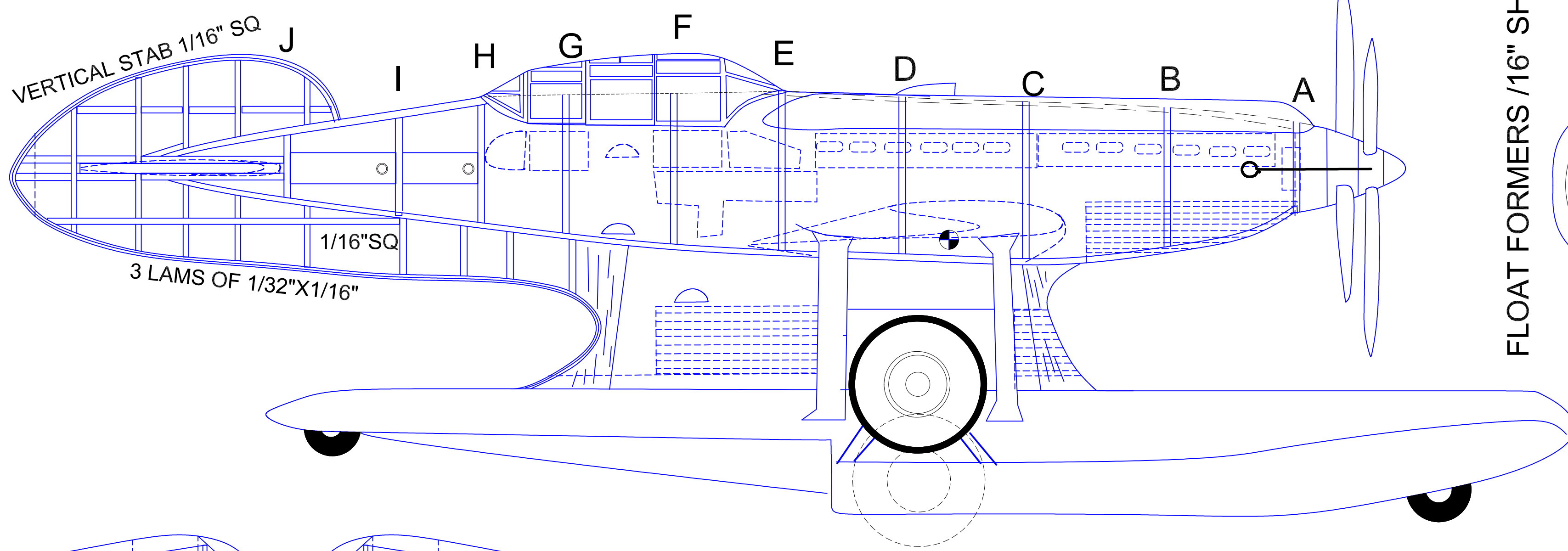

VERTICAL STAB 1/16" SQ
1/16" SQ
3 LAMS OF 1/32" X 1/16"

FLOAT FORMERS /16" SHEET

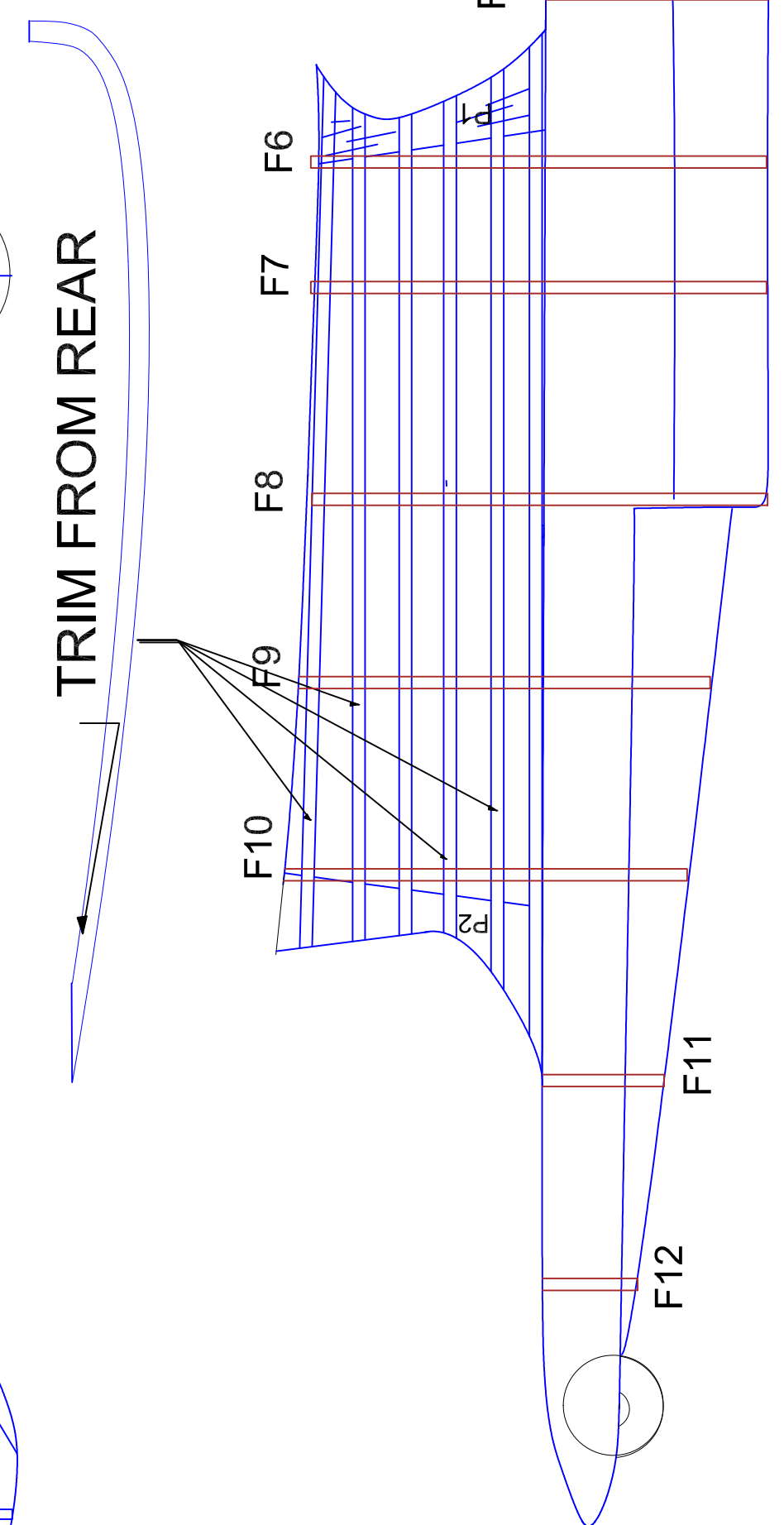
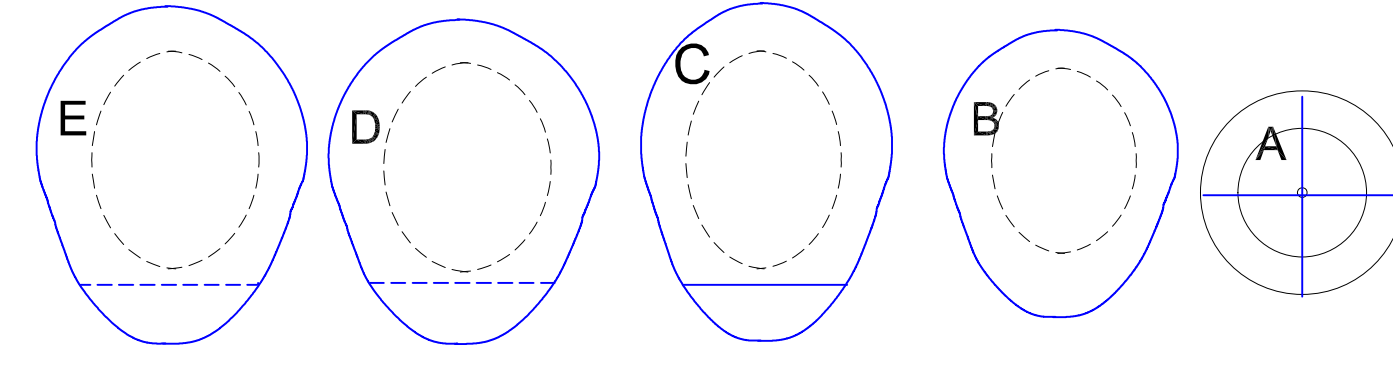
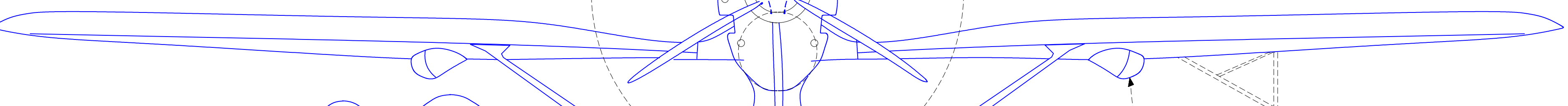
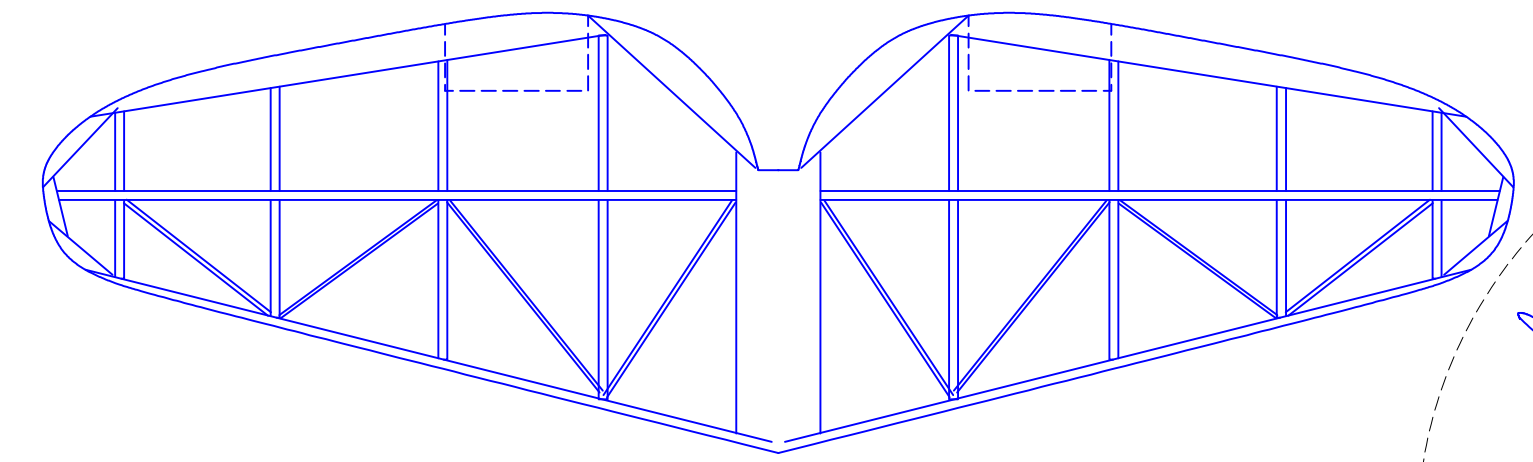
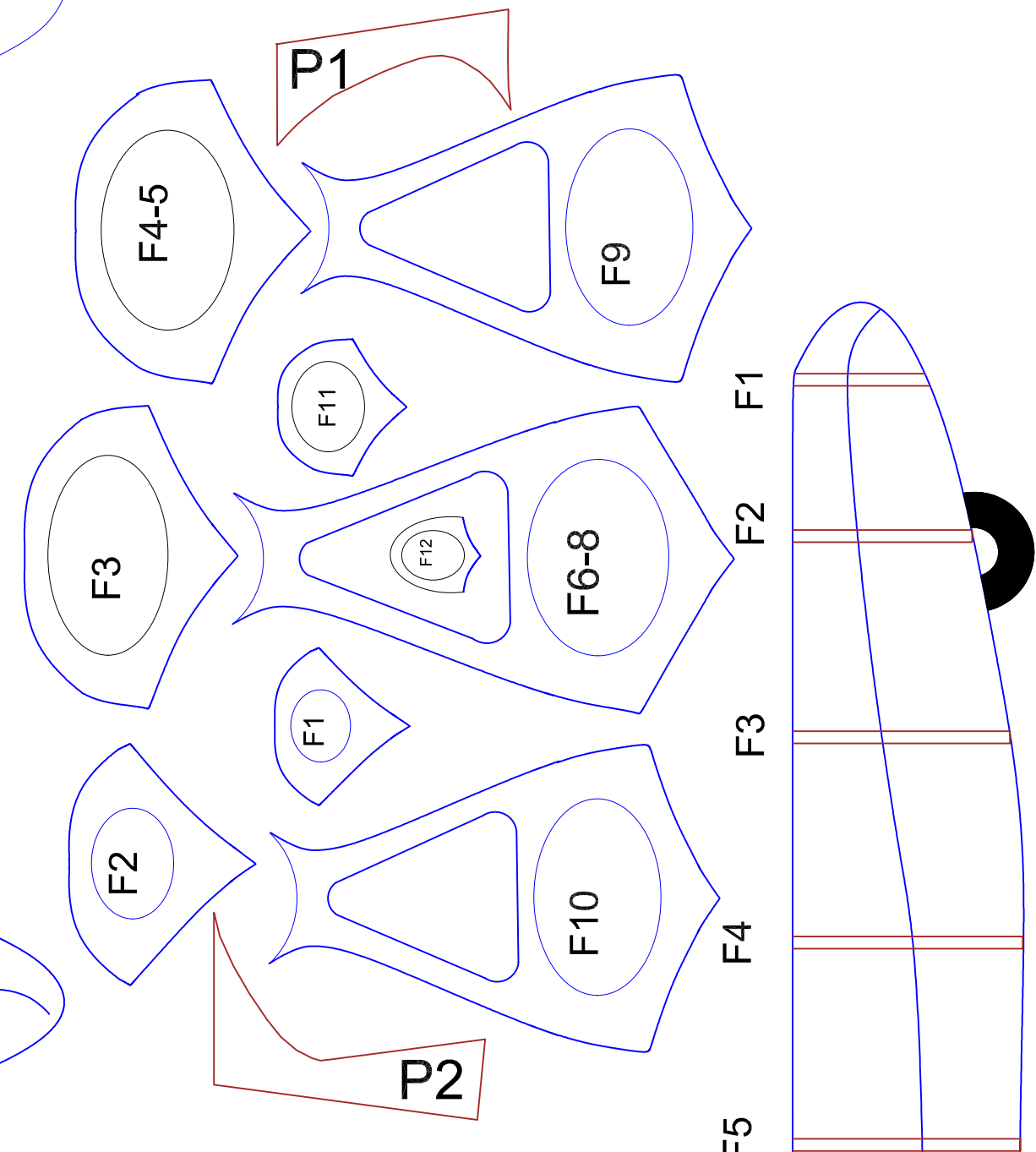

TRIM FROM REAR

T.E. 1/32" X 3/32" LAMINATED 3 STRIPS TAPER TO 1/16"

WING SPARS 1/16" SHEET MAKE 4

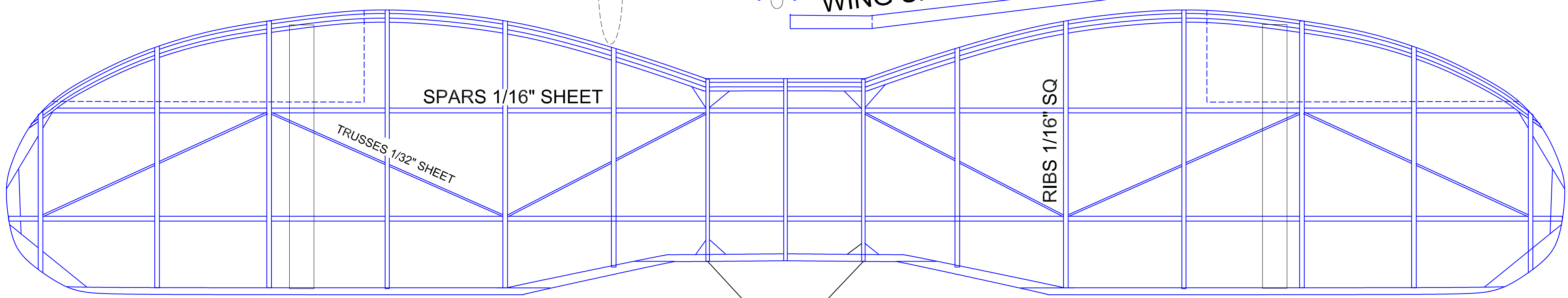

SPARS 1/16" SHEET

TRUSSES 1/32" SHEET

RIBS 1/16" SQ

WING CONST REES' SLICED RIB

DIHEDRAL BREAKS

L.E. 3/32" SQ

2" DIHEDRAL UNDER TIPS

