

DRAWN BY TOM AKERY 29 APR 24

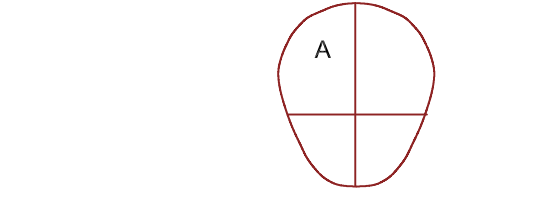

FUSELAGE FORMERS 1/16" SHEET

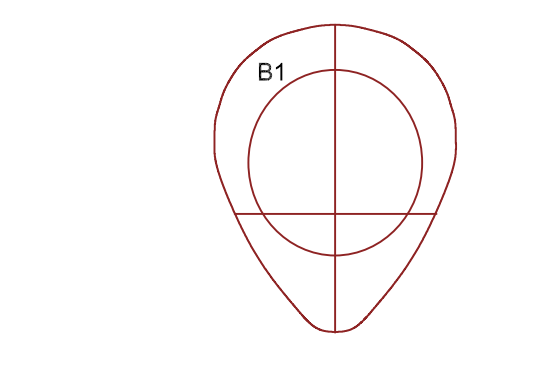
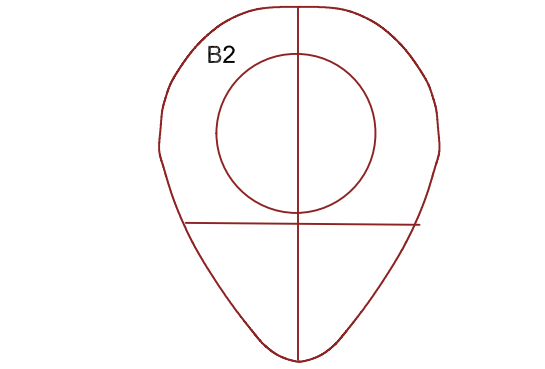
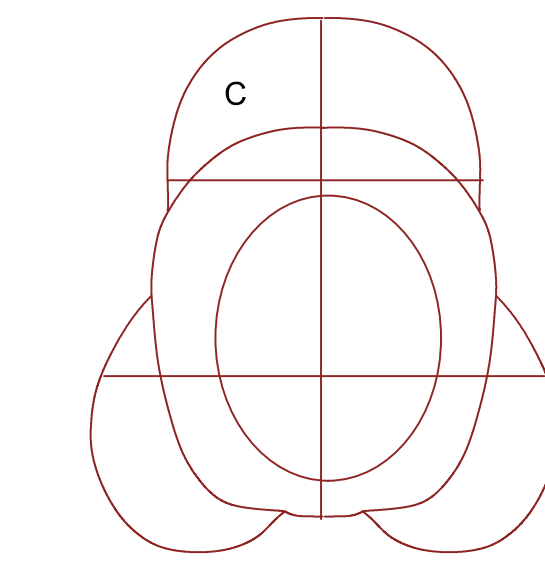
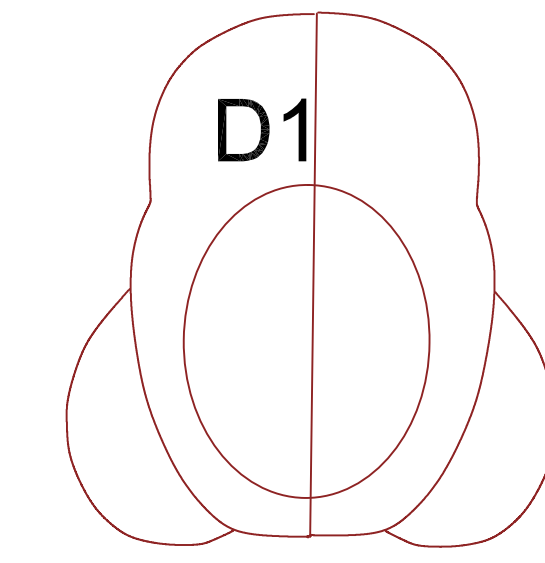
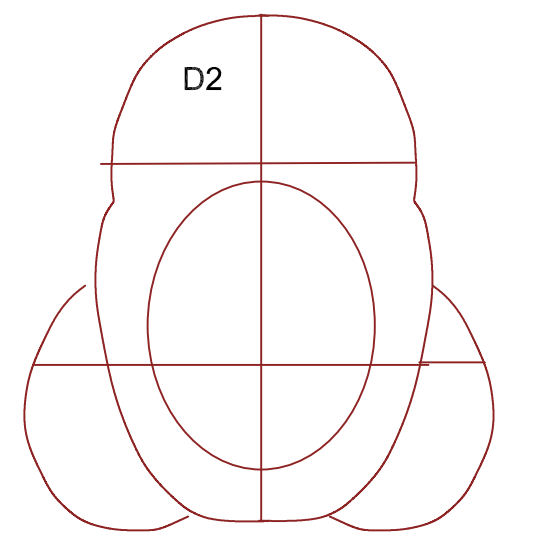
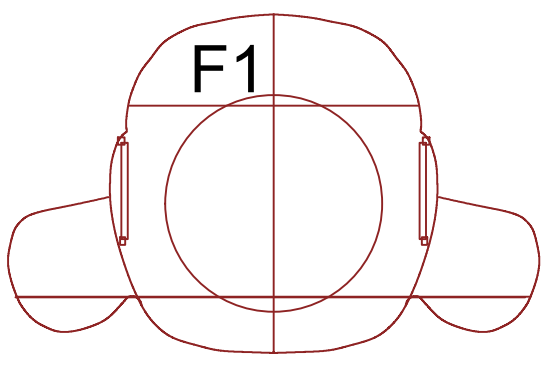
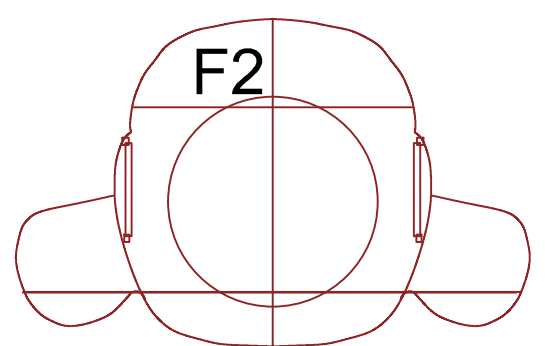
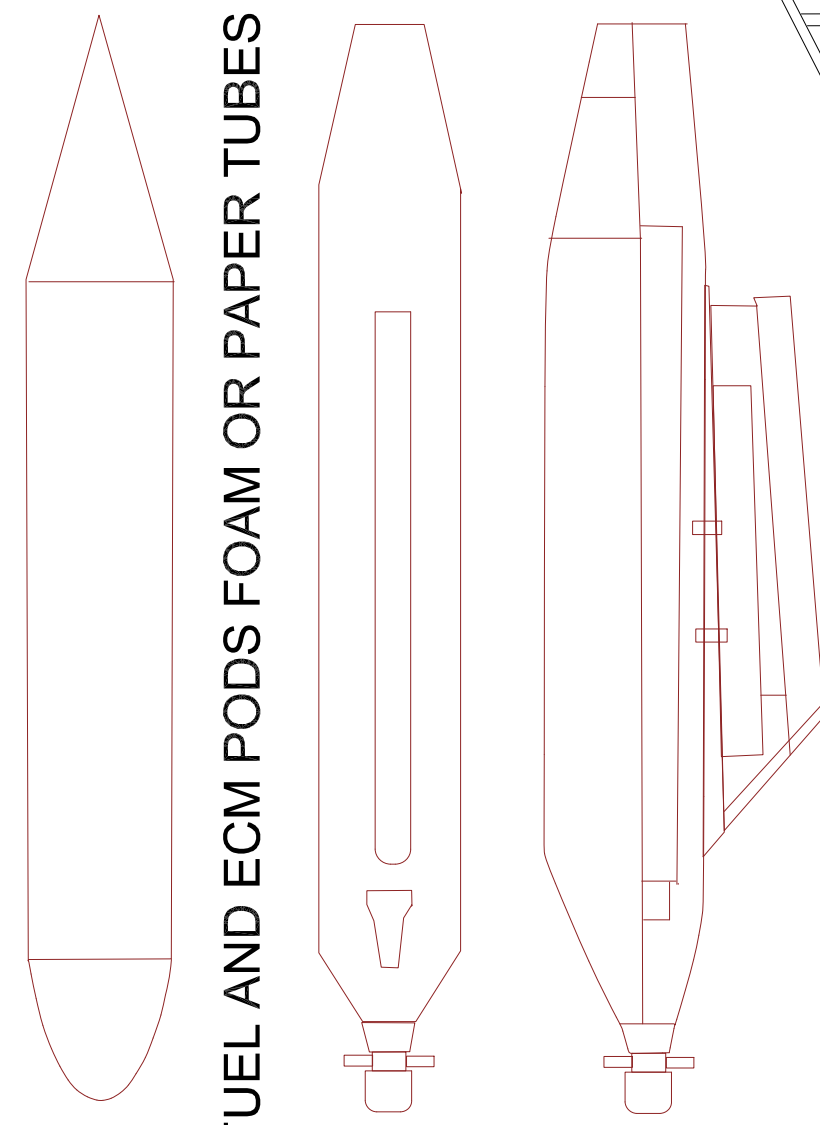
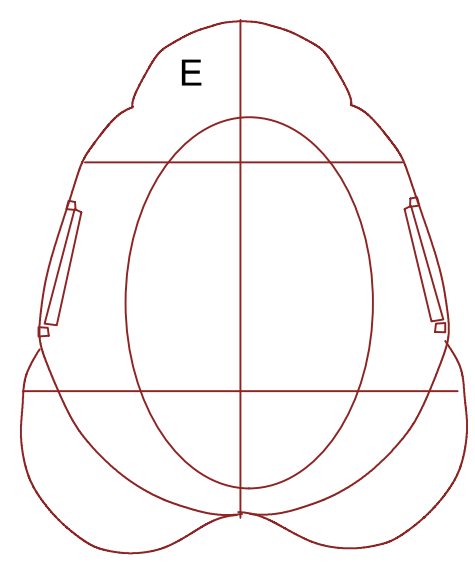
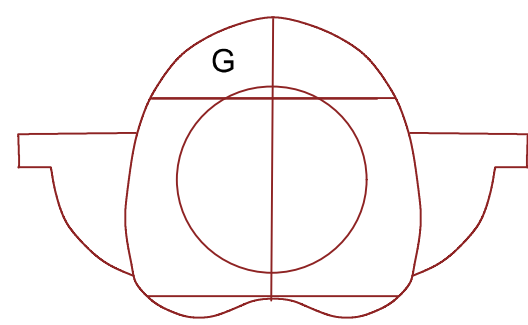
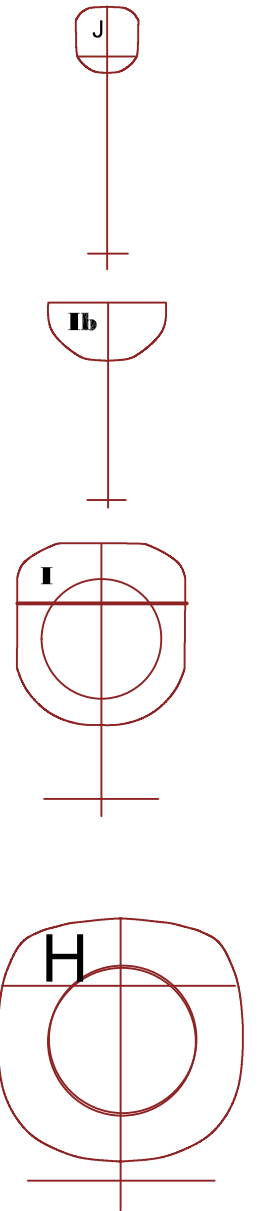

FUEL AND ECM PODS FOAM OR PAPER TUBES

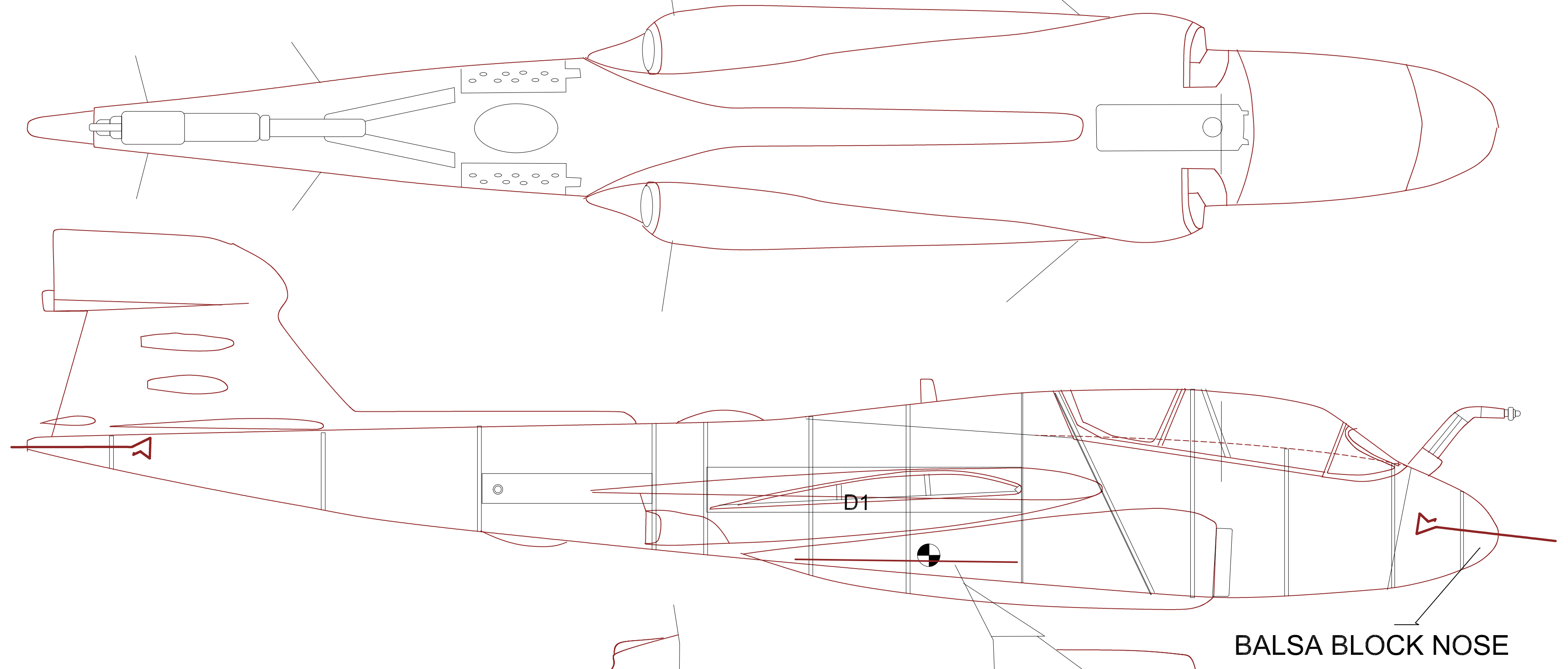
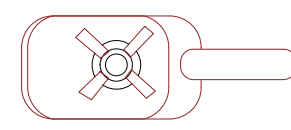
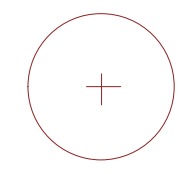

BALSA BLOCK NOSE

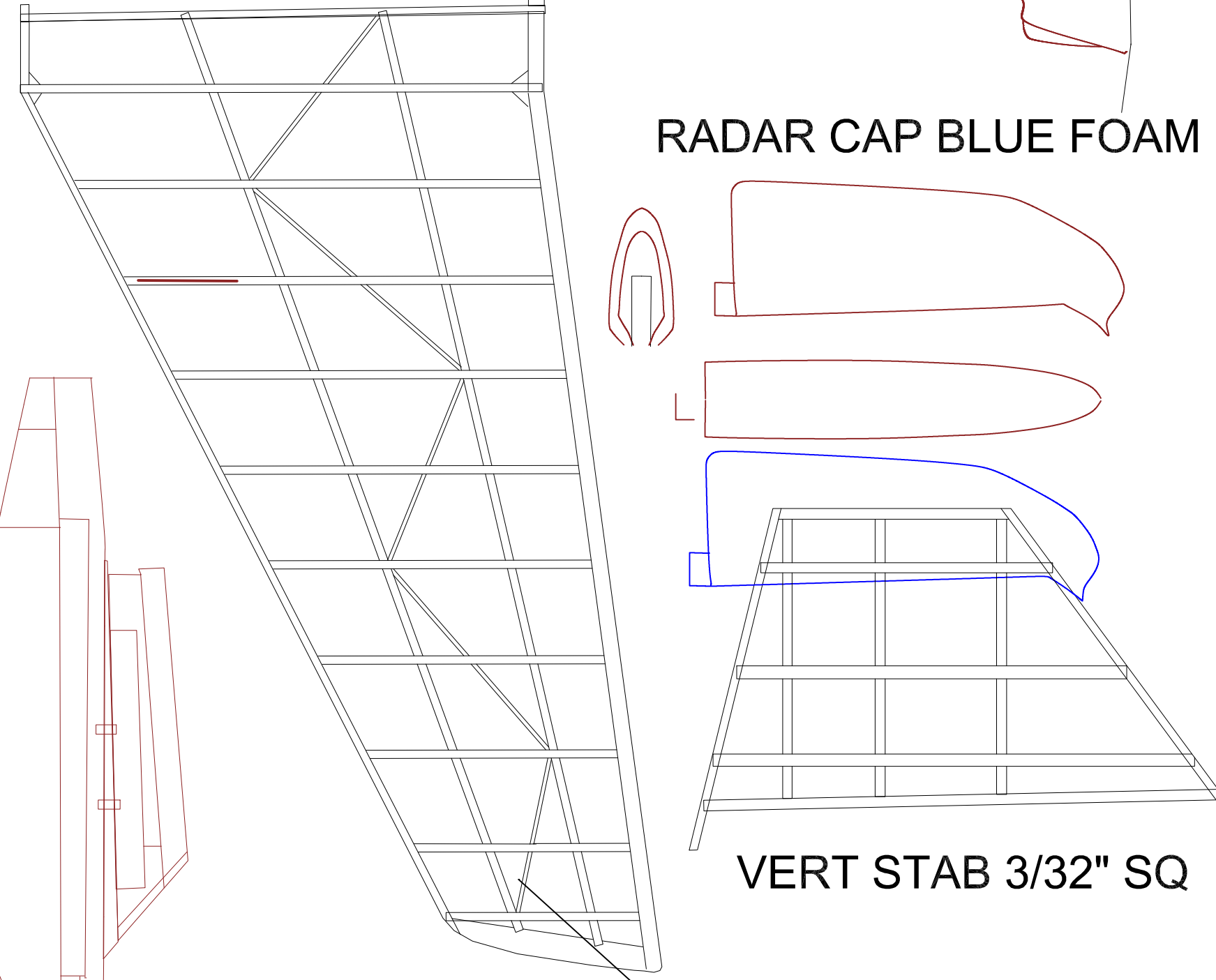
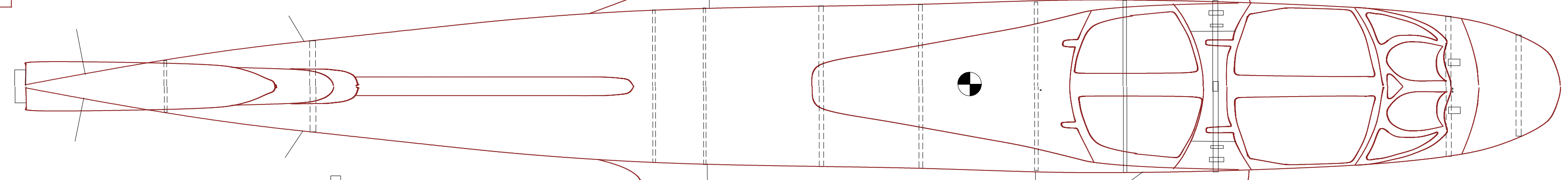

TRUSSES 1/32" SHEET

RADAR CAP BLUE FOAM

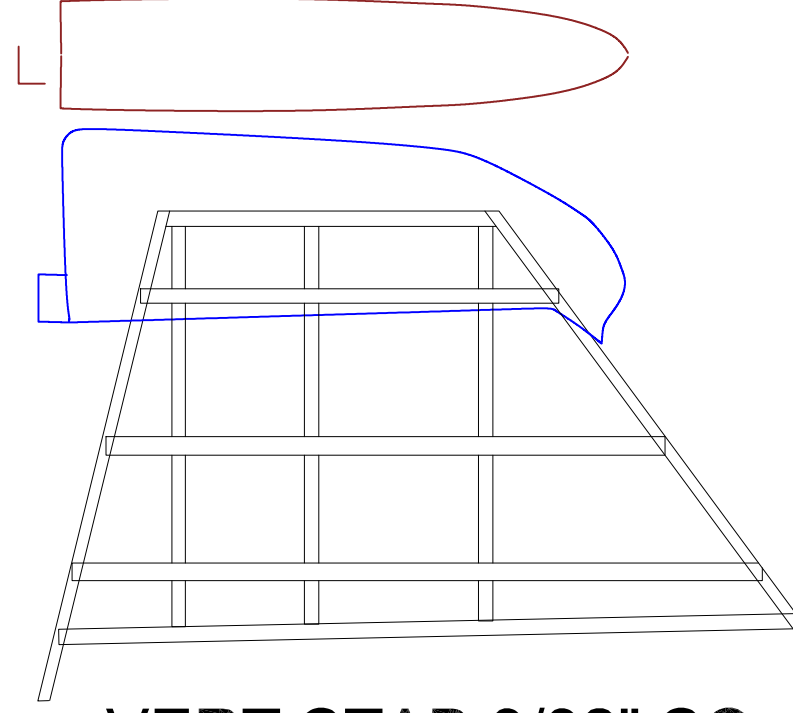
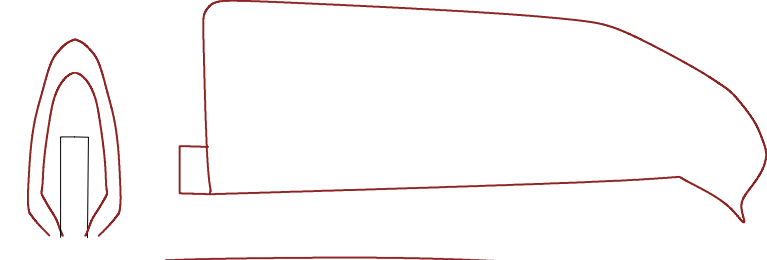

VERT STAB 3/32" SQ

HORIZONTAL STAB 3/32" SQ

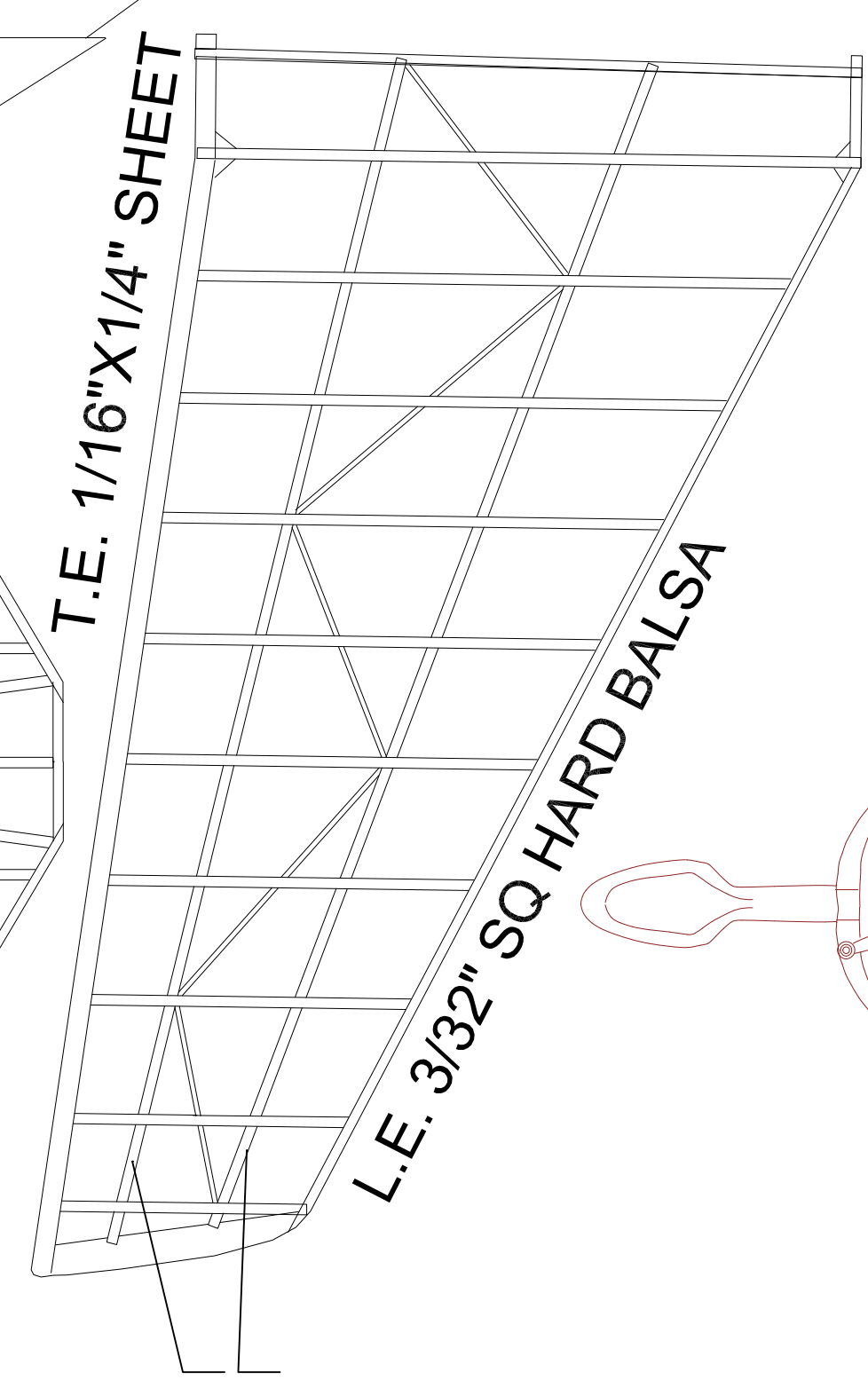
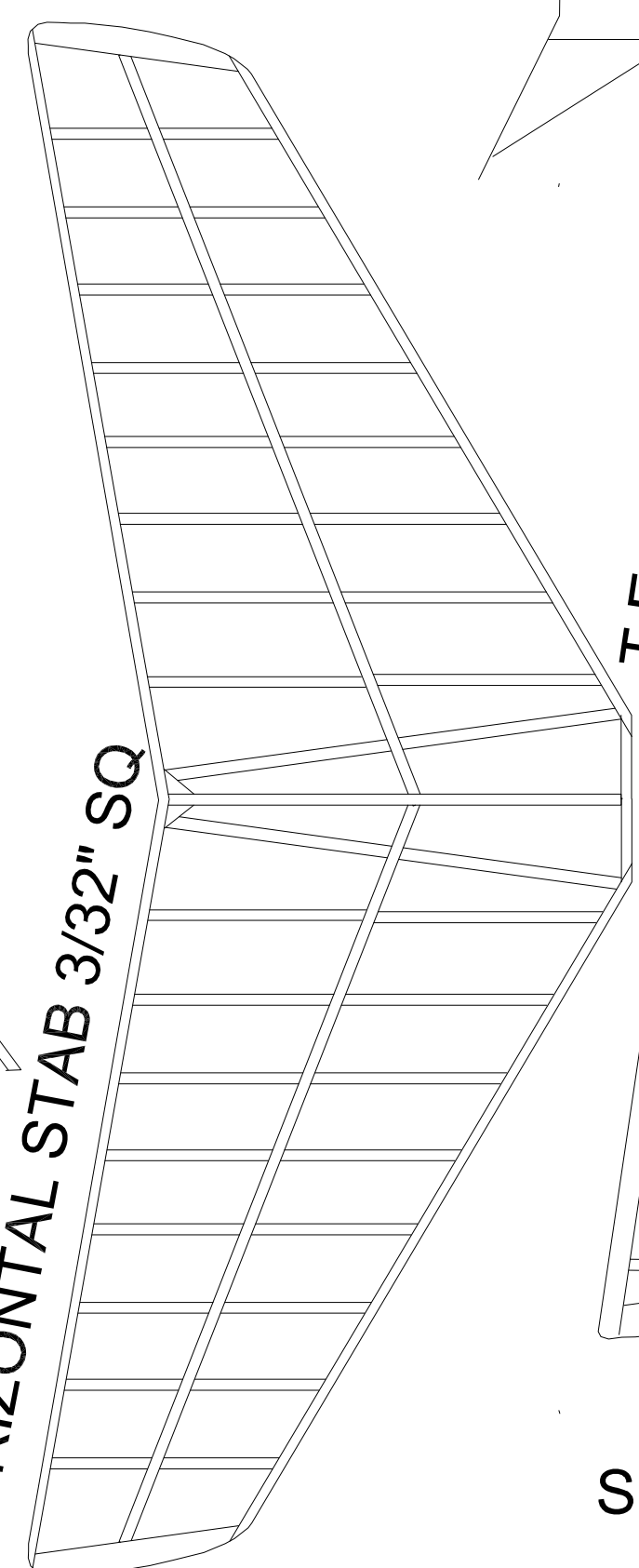

SPARS 1/16" SHEET

T.E. 1/16"X1/4" SHEET

L.E. 3/32" SQ HARD BALS

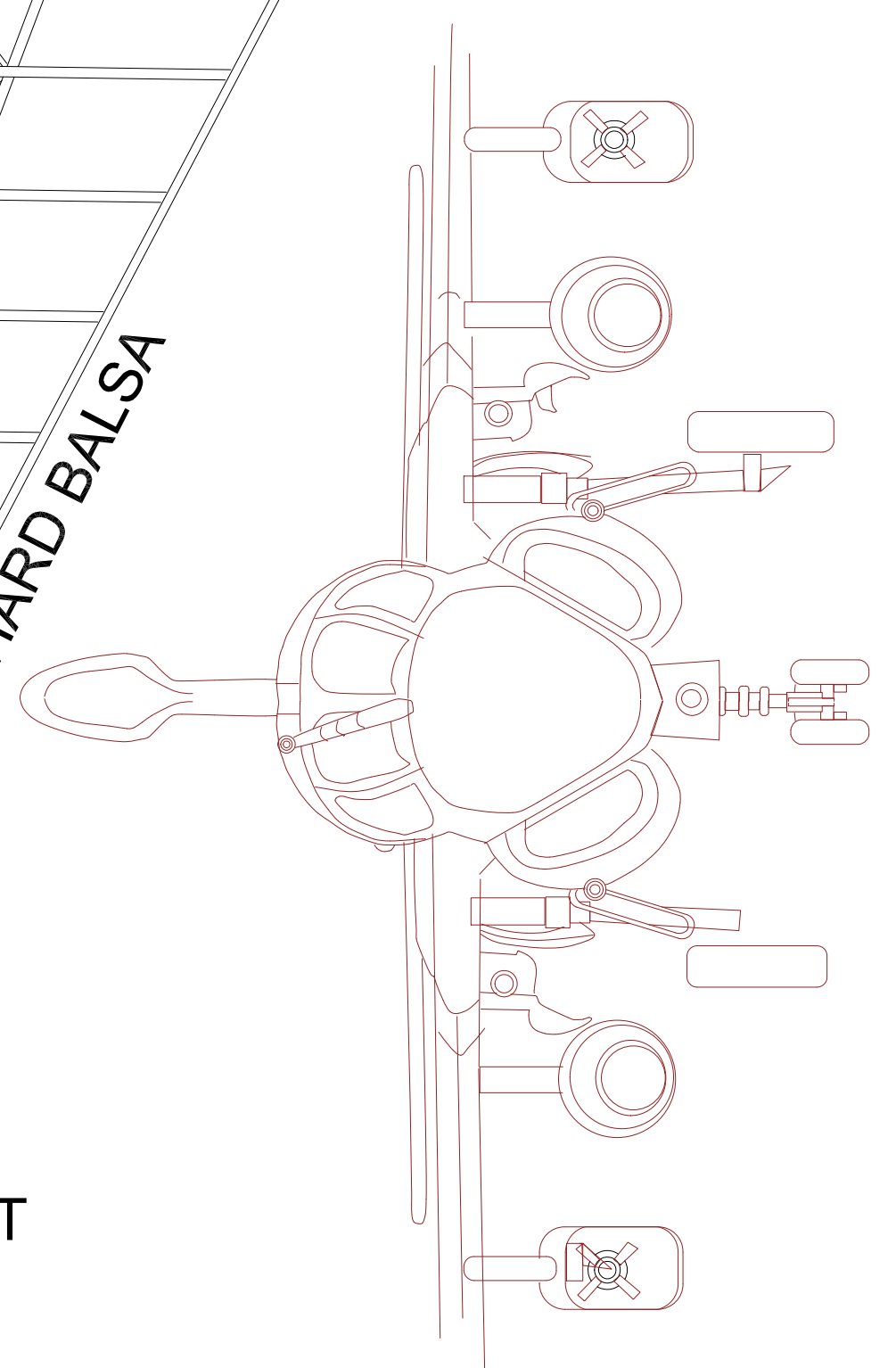

# GRUMMAN EA-6B PROWLER