

# LAVOCHKIN LA-5FN

DRAWN BY TOM AKERY FROM 3 VIEW ON INTERNET  
27" RUBBER POWERED 21 APR 2024

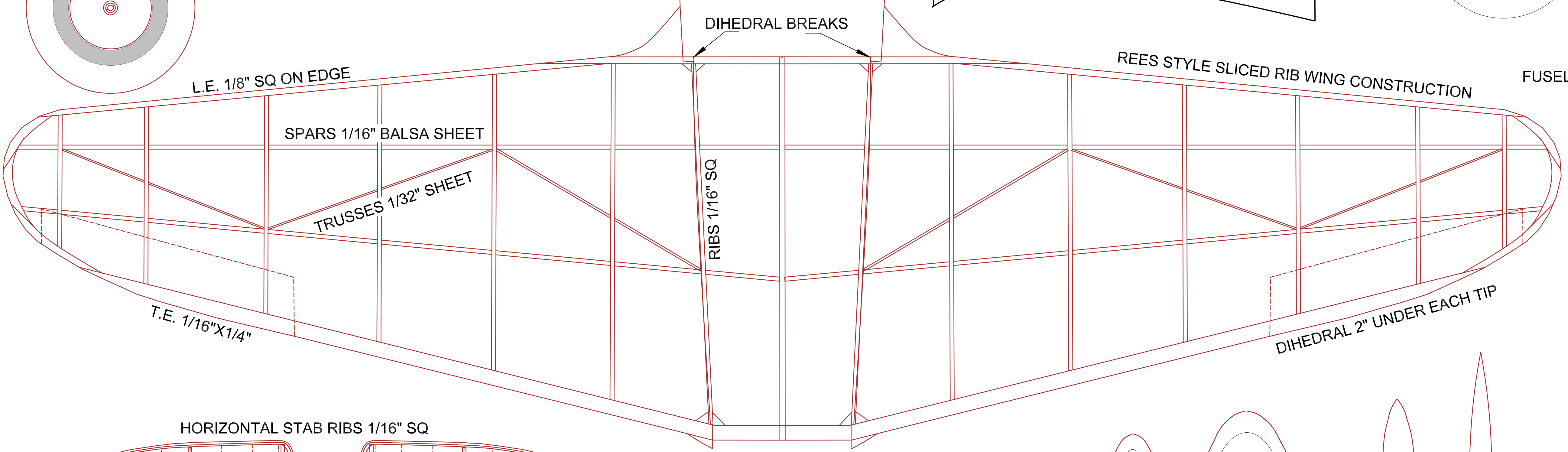

FUSELAGE FORMERS/BULKHEADS 1/16" SHEET BALSA

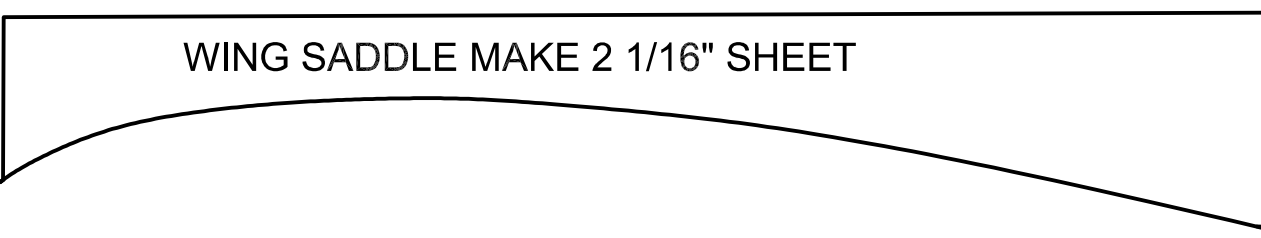
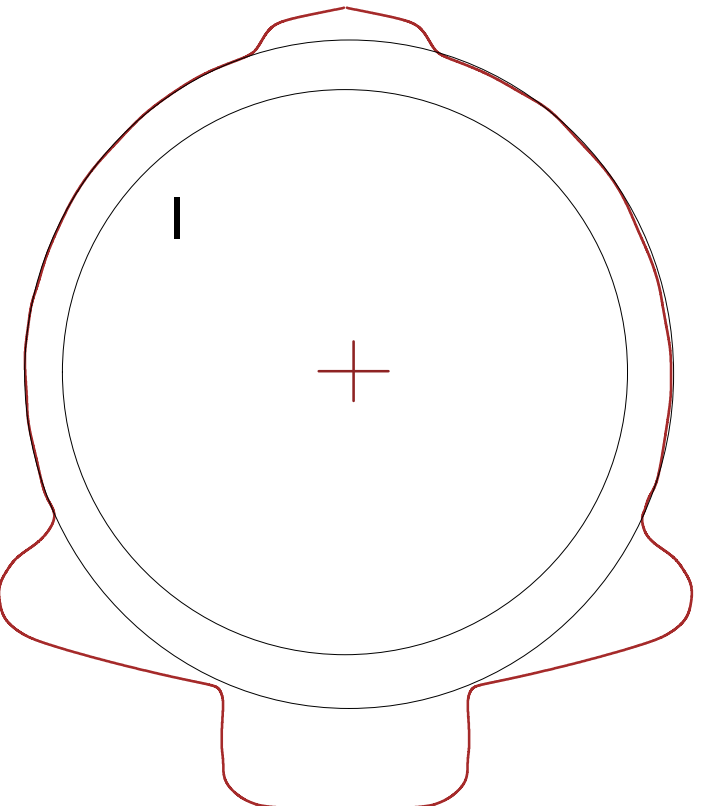
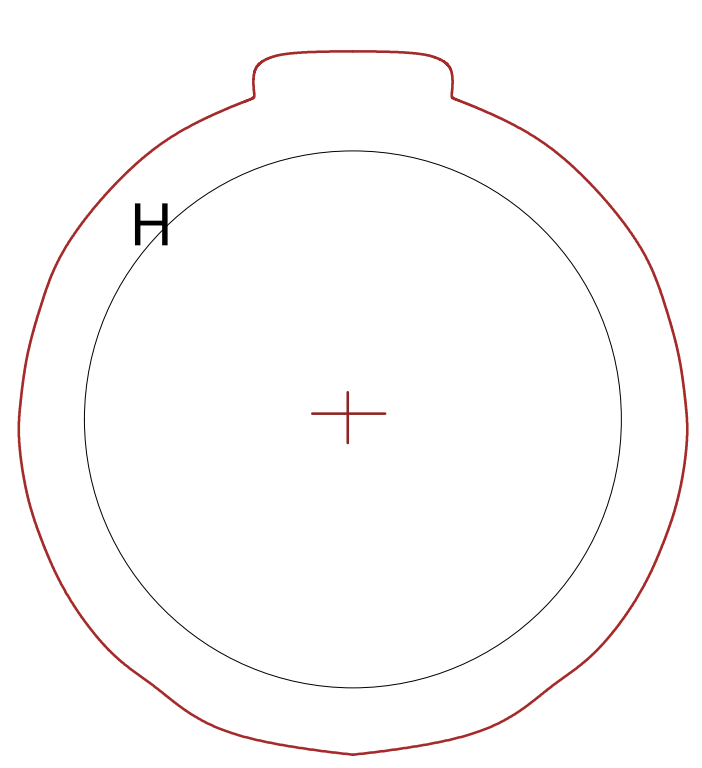
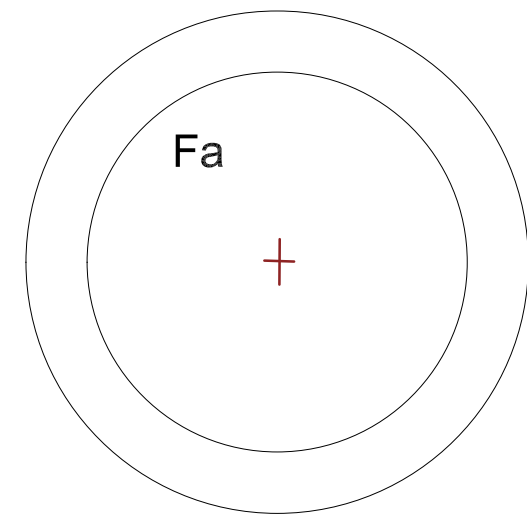
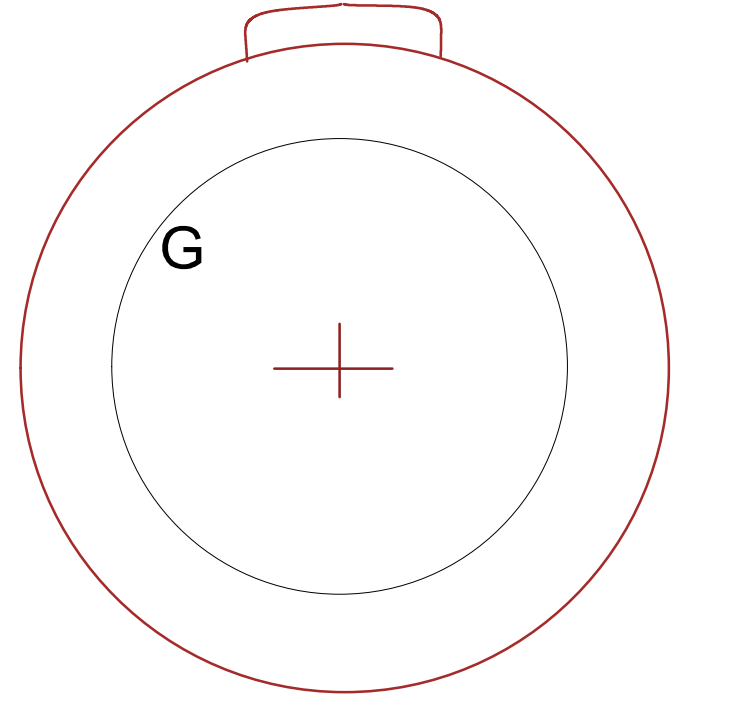
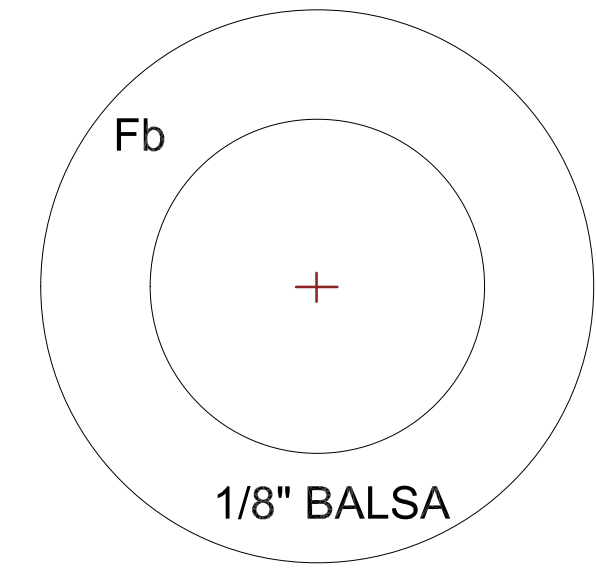
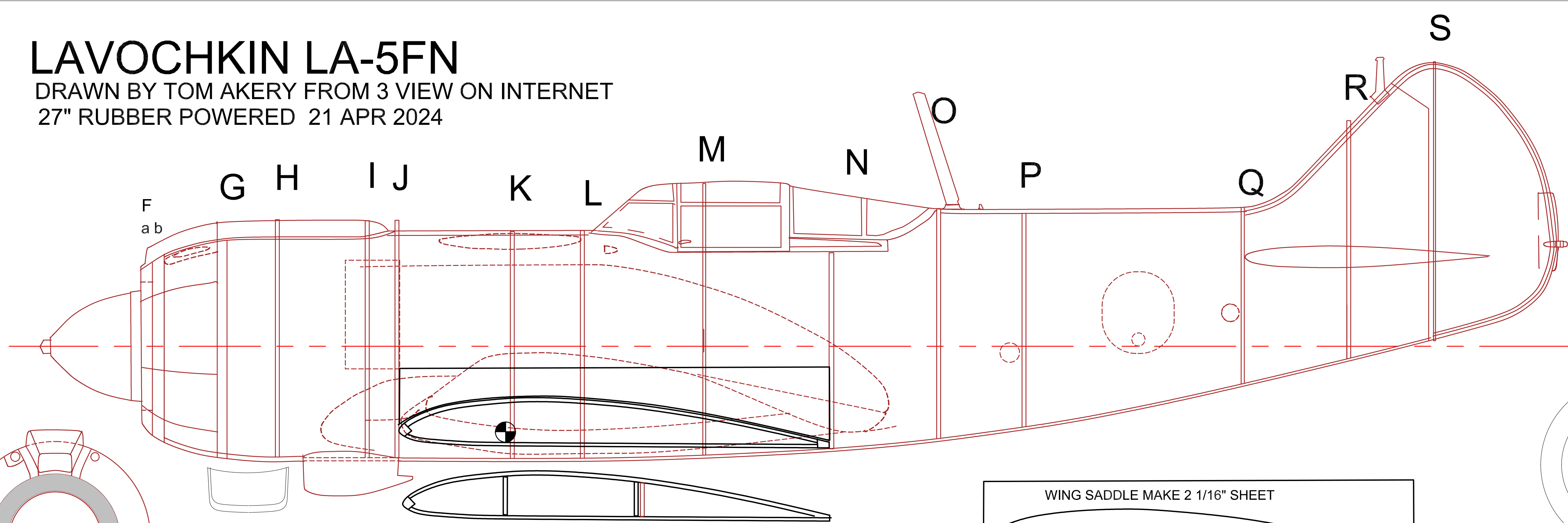