

BABY LIGHTWEIGHT.
DESIGNED BY L.E.W. BURBRIDGE. DRAWN BY A.H.S.

SCALE: 1/2 FULL SIZE

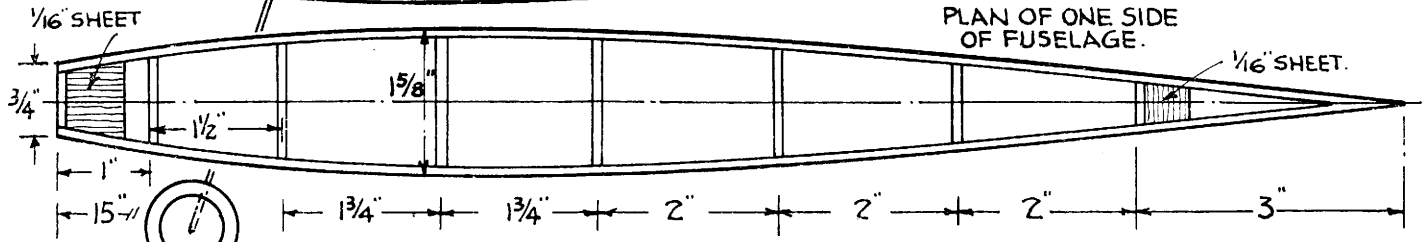
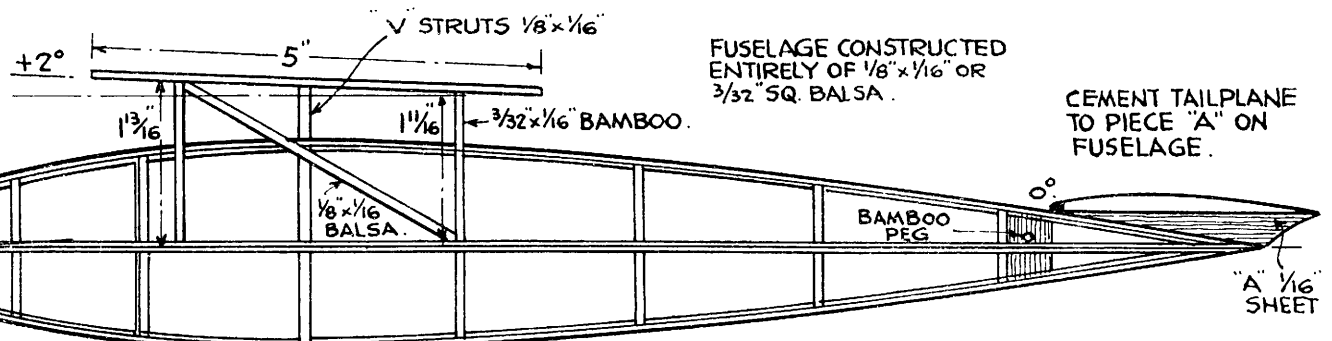

CERTIFIED PERFORMANCE.

FLIGHT N°	SECONDS
1	57.4
2	61.2
3	63.8
4	61.4
5	73.4
6	67.6
7	81.2
8	66.8
9	76.6
10	72.4

AVERAGE OF TEN CONSECUTIVE FLIGHTS..... 68.18 SECS.

WHOLE MODEL COVERED WITH JAP TISSUE & WATER SPRAYED, DOPE WING ONLY.

1" HARDWOOD WHEELS.

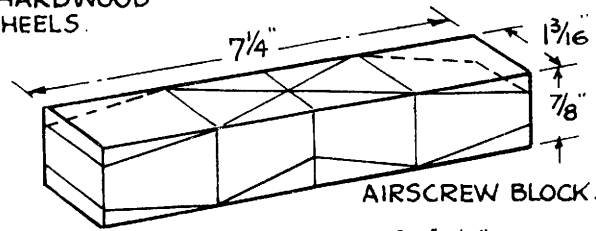

POWER: OUTDOORS- 2 STRANDS 3/16" x 1/20" 15" LONG, MAX. TURNS 925 APPROX. INDOORS- INCREASE DIAM. TO 8" WITH 2 STRANDS 3/16" x 1/30", 20" LONG. MAX. TURNS 1,500 APPROX.

SAND 1/8" SQ. PIECES TO ROUGH AIRFOIL SHAPE

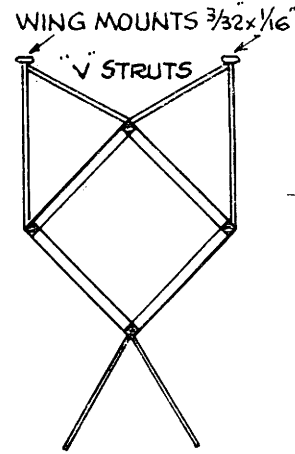
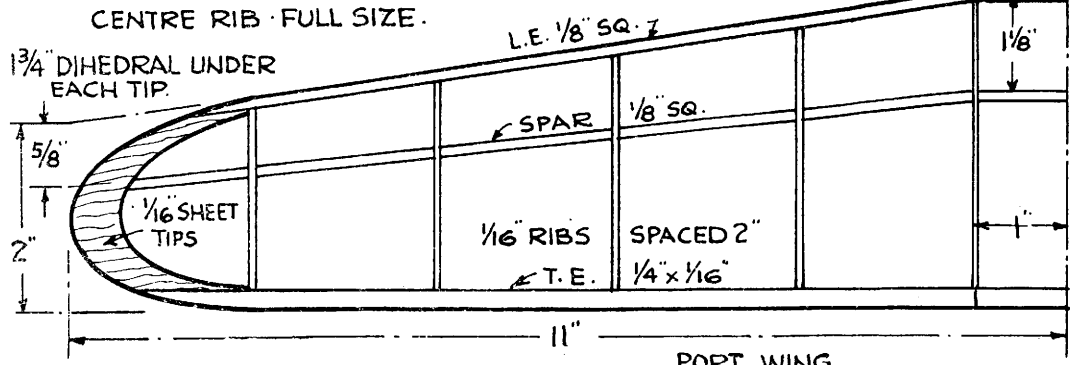
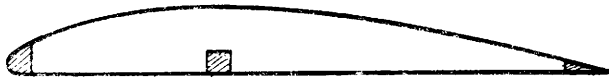
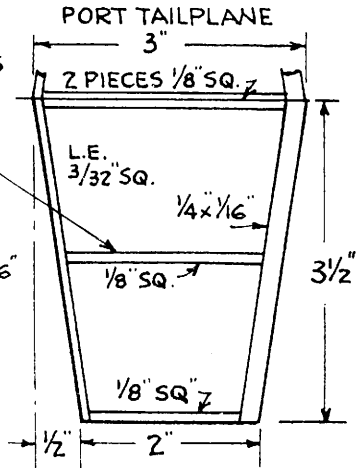

U/C BENT FROM ONE PIECE OF 20 S.W.G.

