

* NOT FULL-SIZE. ENLARGE PLAN BY 140% *should be 22" span*

FROM 2/43 AIR AGE MAGAZINE

FLY THIS DEPENDABLE-PERFORMING CONVERTIBLE CABIN MODEL

CONVERTIBLE CABIN MODEL

WHEELS OR SKIS

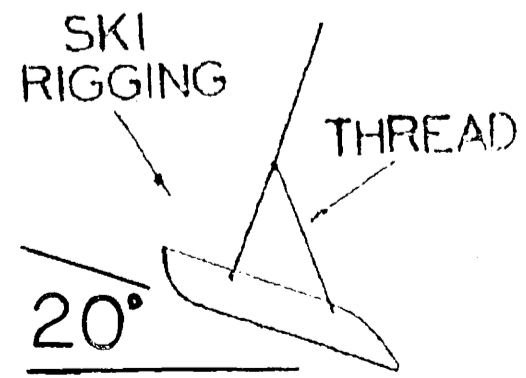
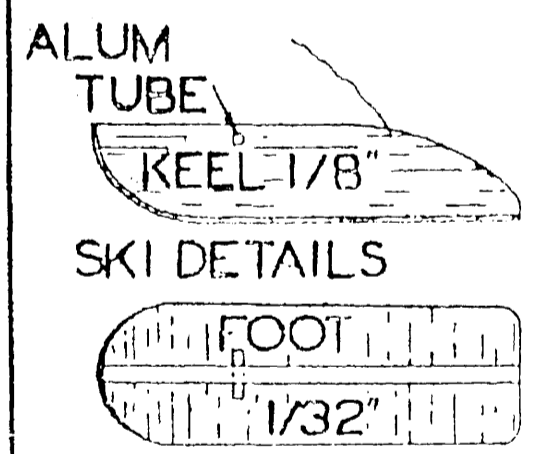
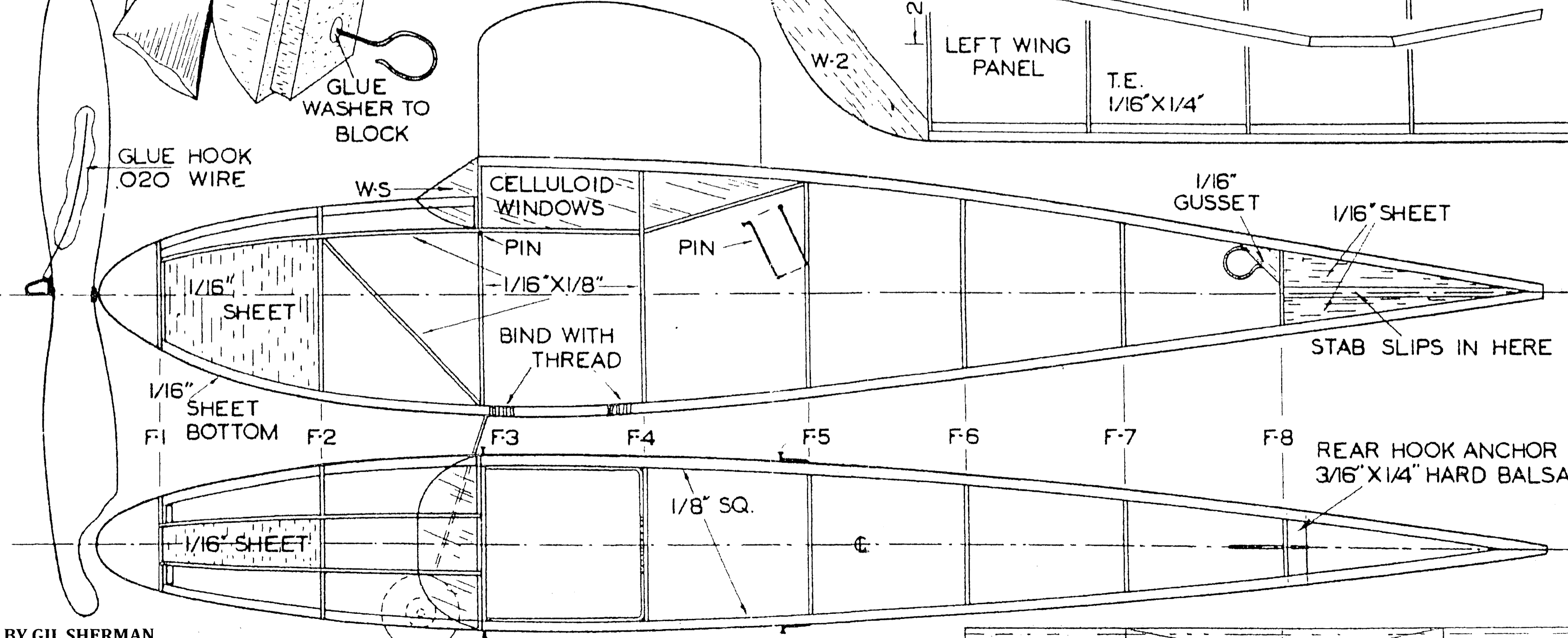
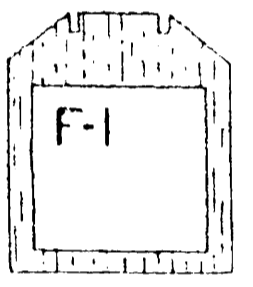
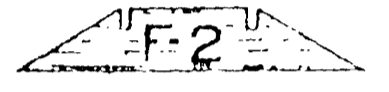
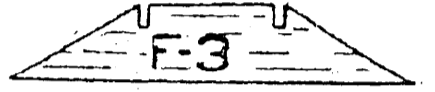
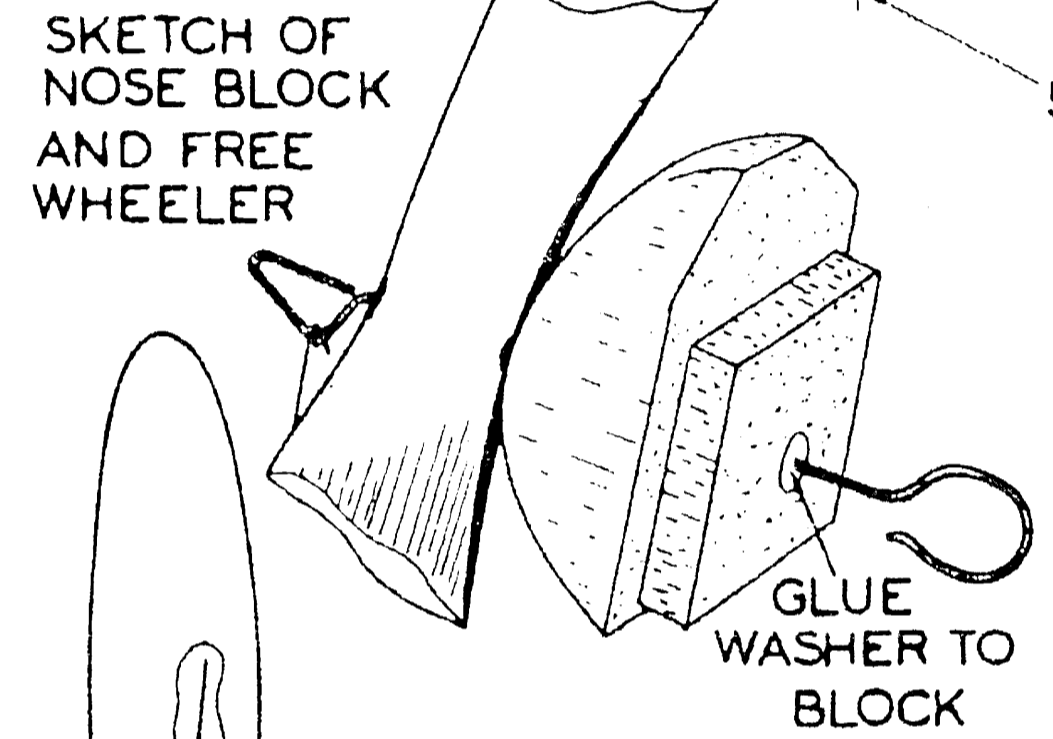
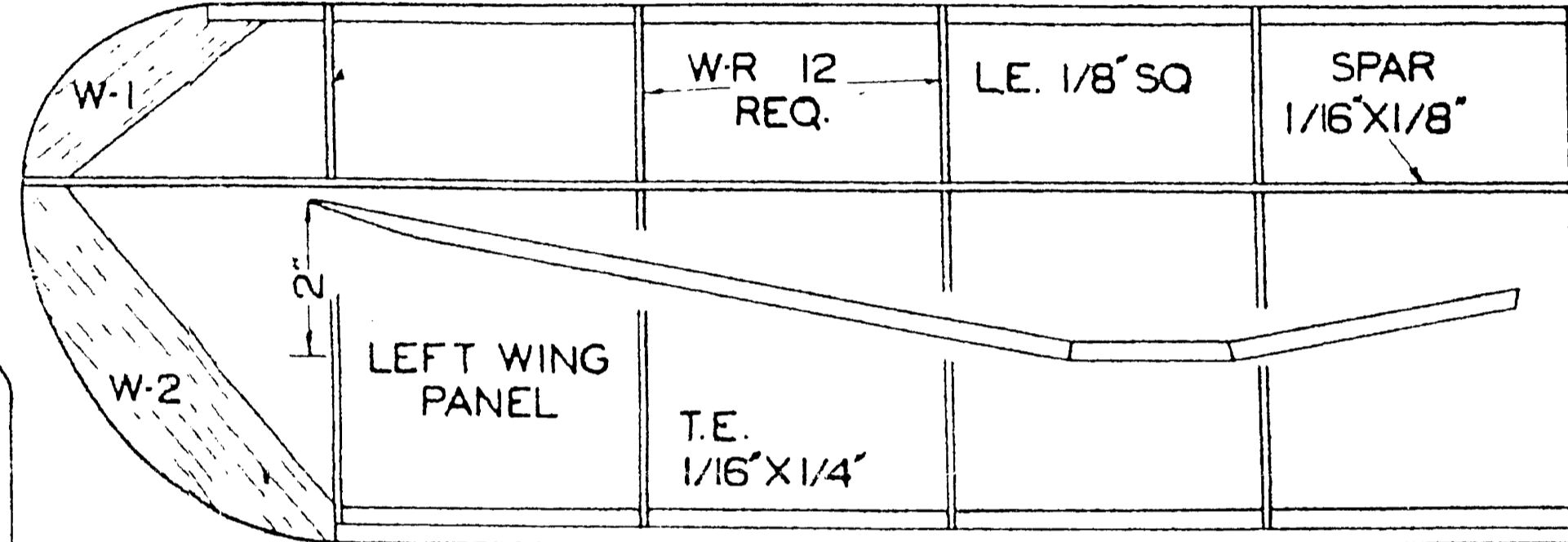
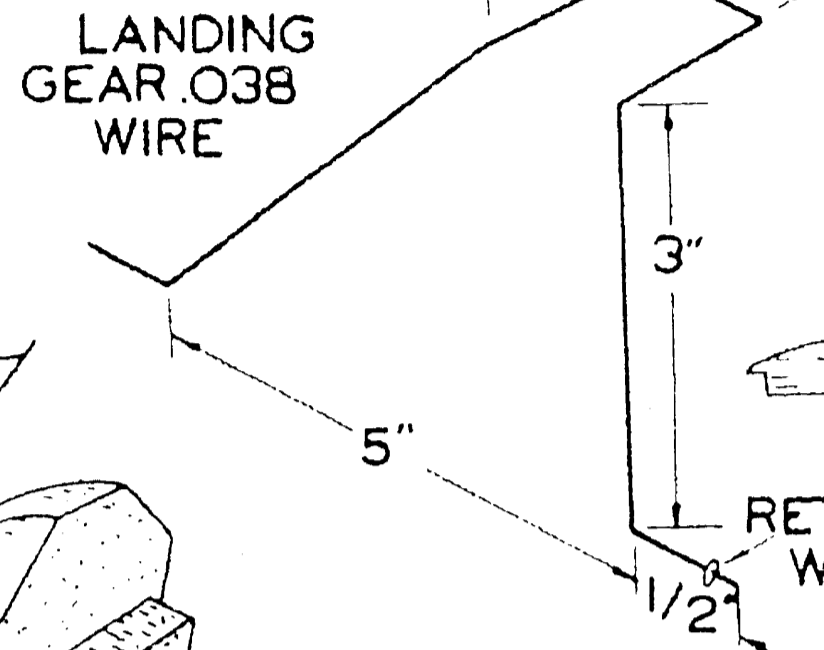
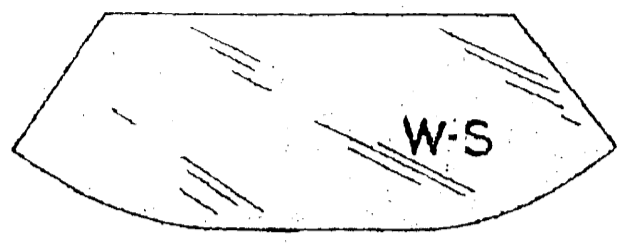
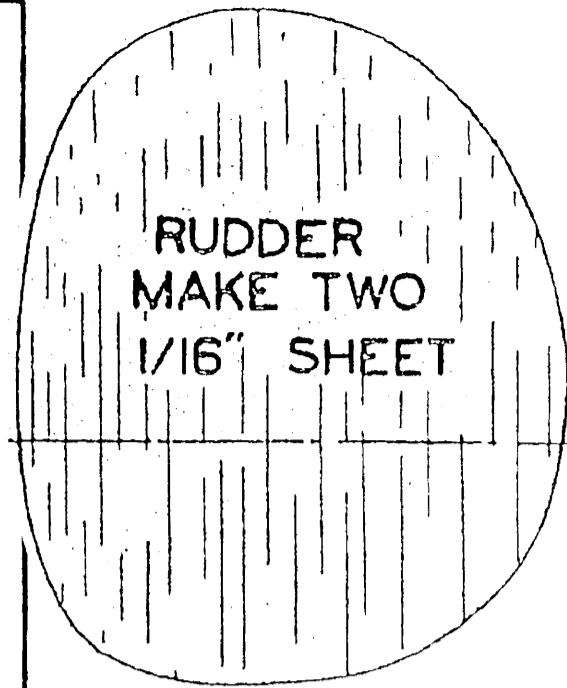
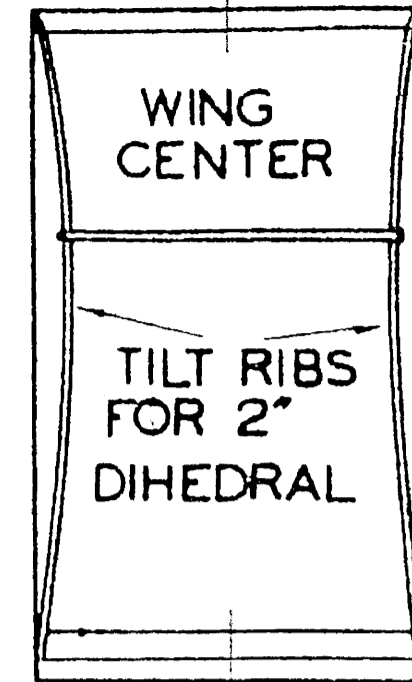
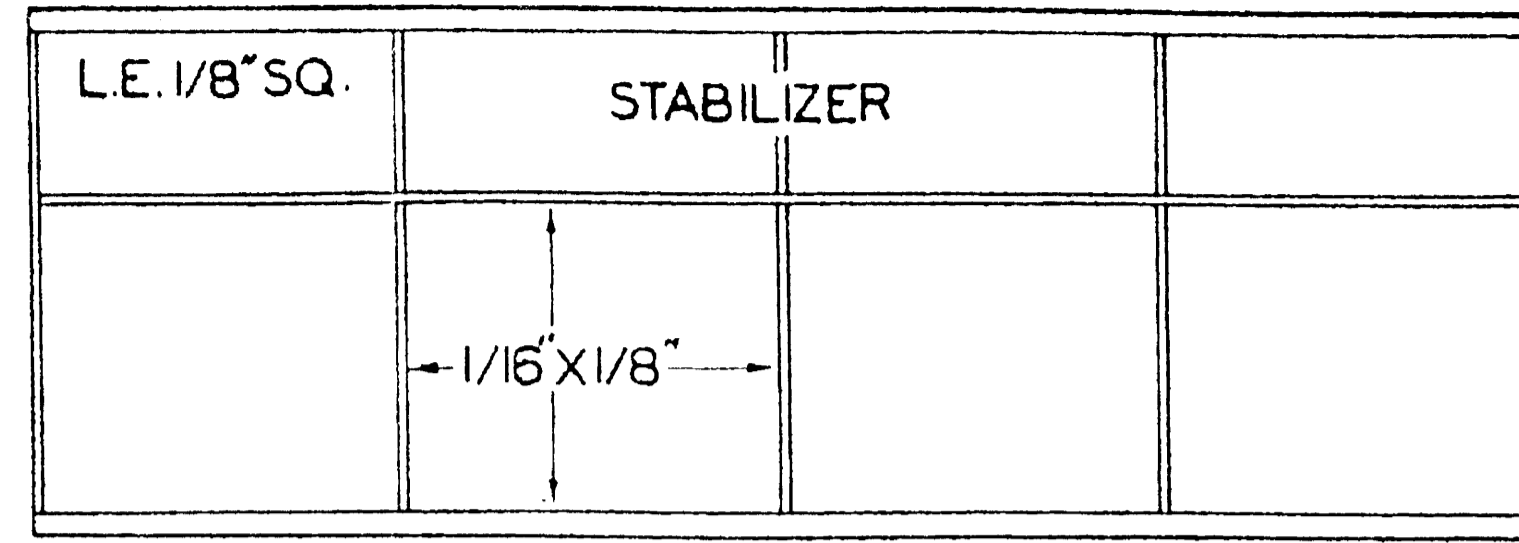
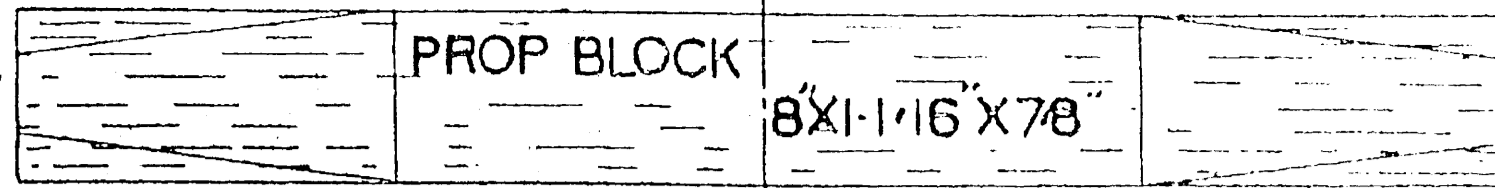

BY GIL SHERMAN