

WING

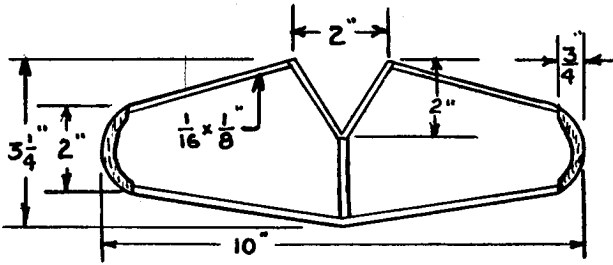

ELEVATOR

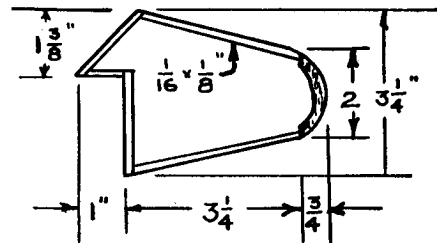

RUDDER

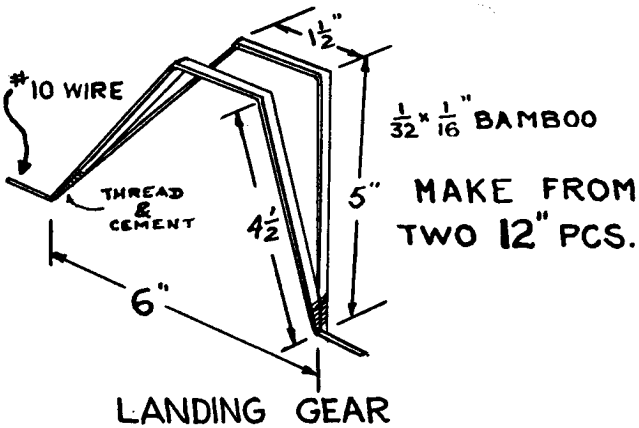

LANDING GEAR

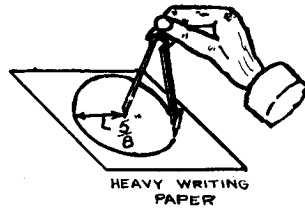

CUT OUT FOUR PAPER DISKS ¹/₄" IN DIAM.

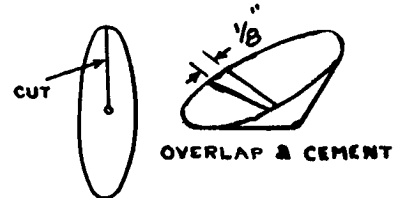

JOIN TWO DISKS TO FORM WHEEL



PAPER WHEELS

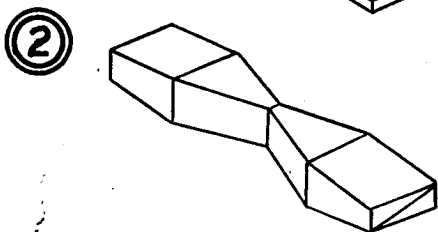
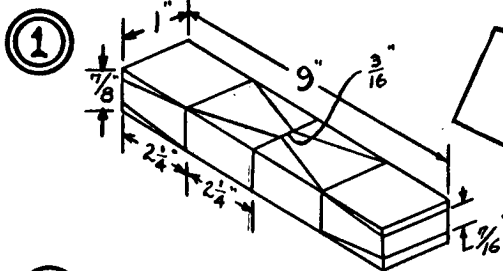

PROPELLER

