

Installation details for geared KP-00 electric motor

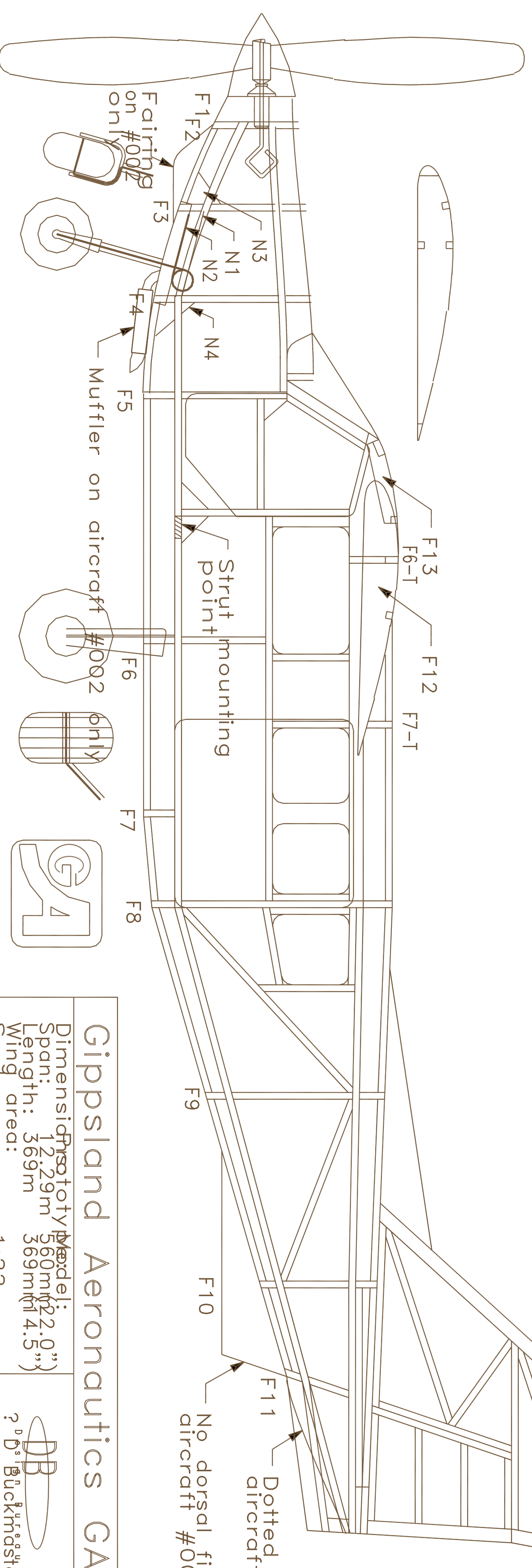

Gipsland Aeronautics GA-8
 Dimensions: 1229mm (48.75")
 Span: 360mm (14.17")
 Length: 369mm (14.53")
 Wing area: 1:22
 Model designed by Derek June 1999

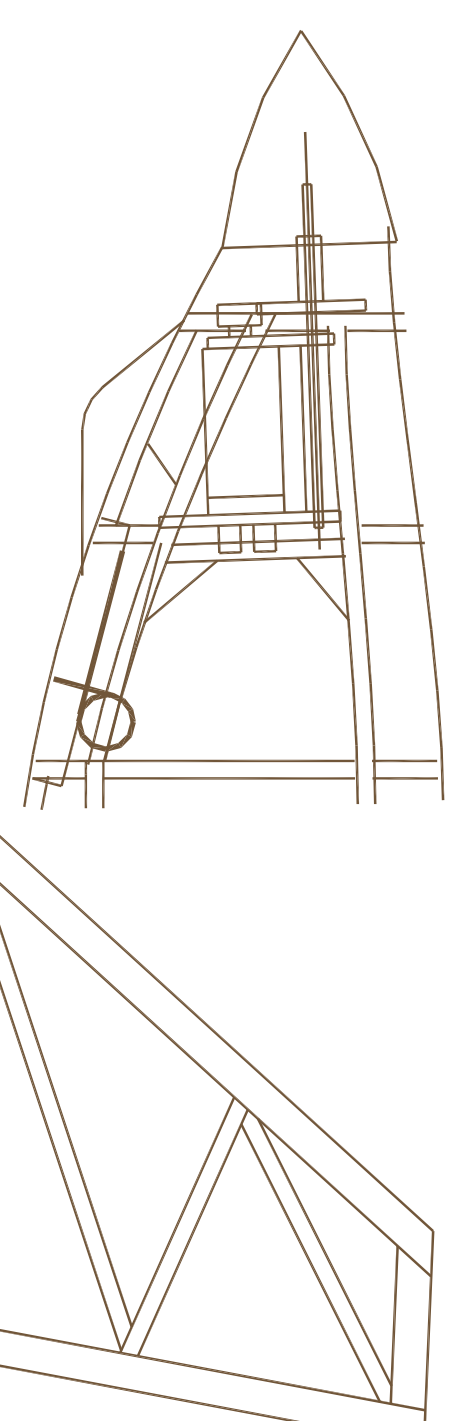
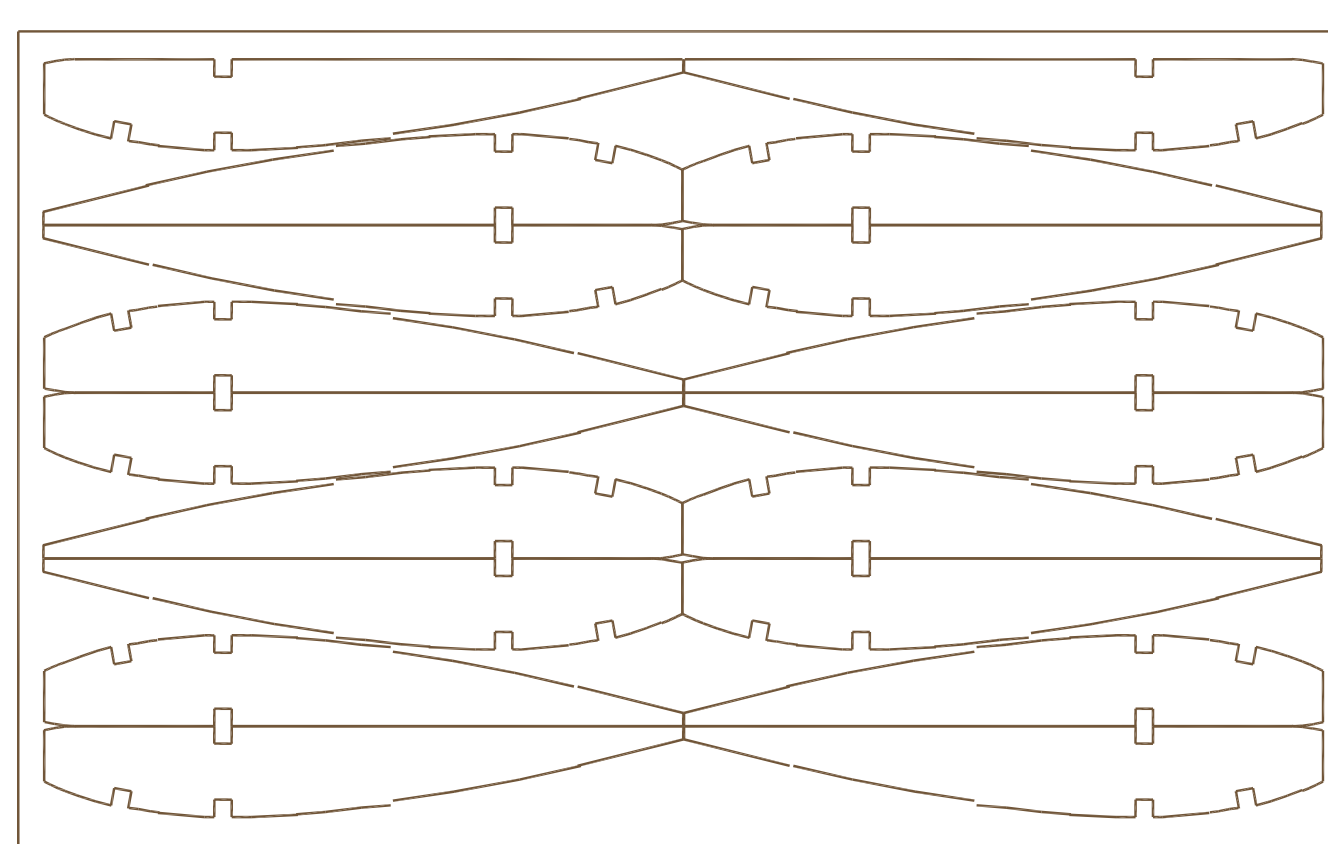
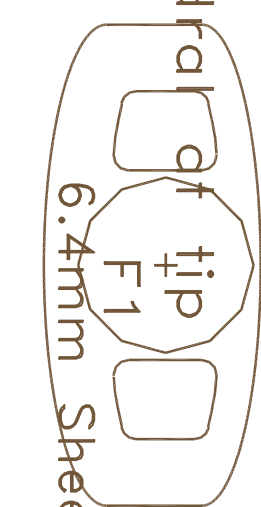
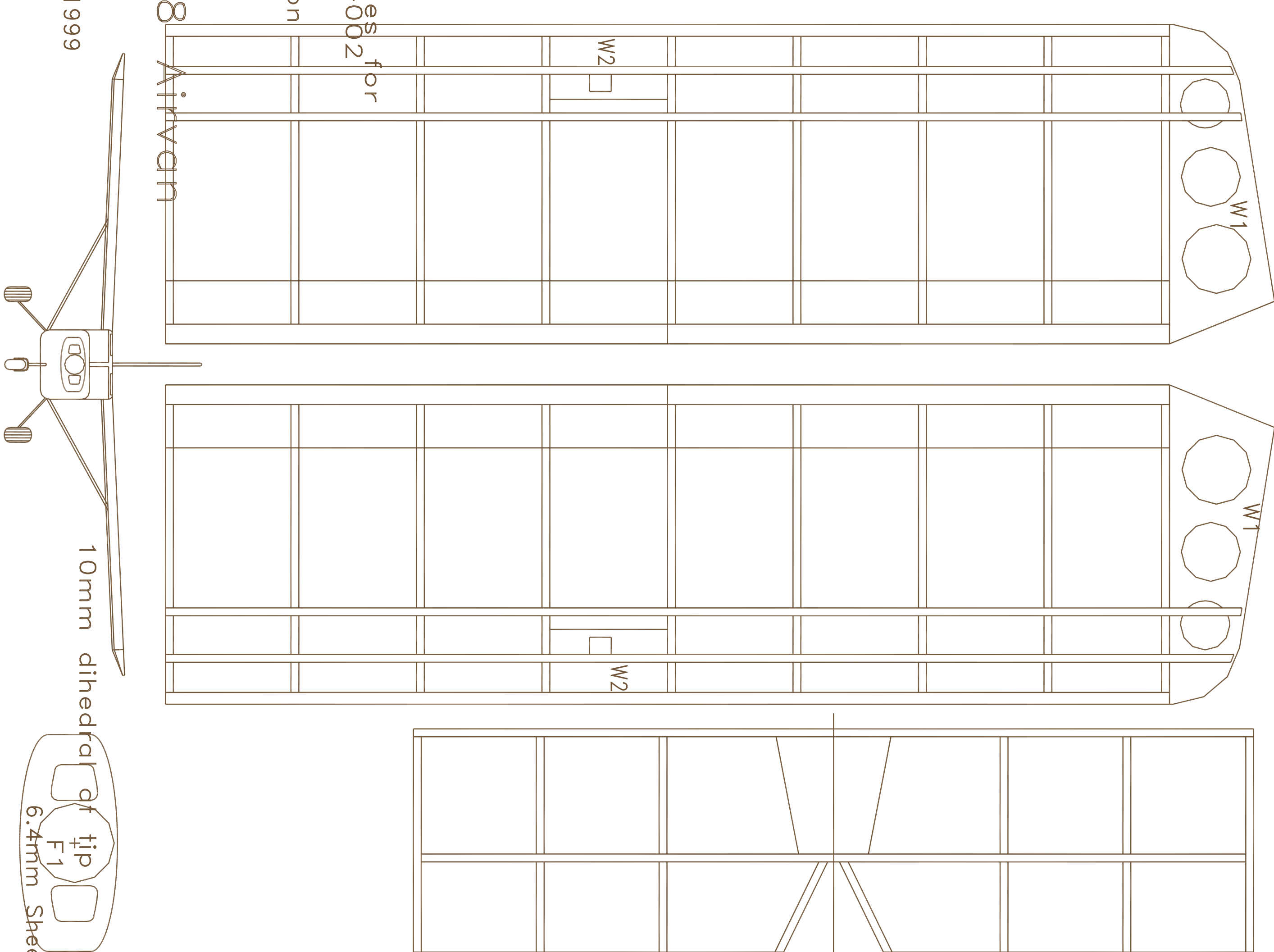
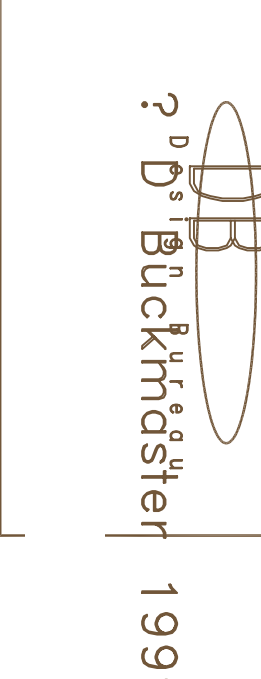

Nose landing gear wire pattern

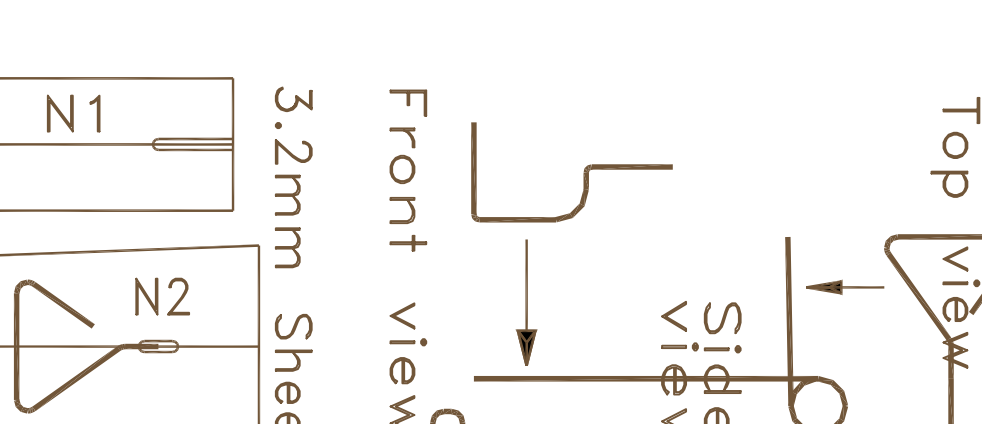

Front view
 Side view

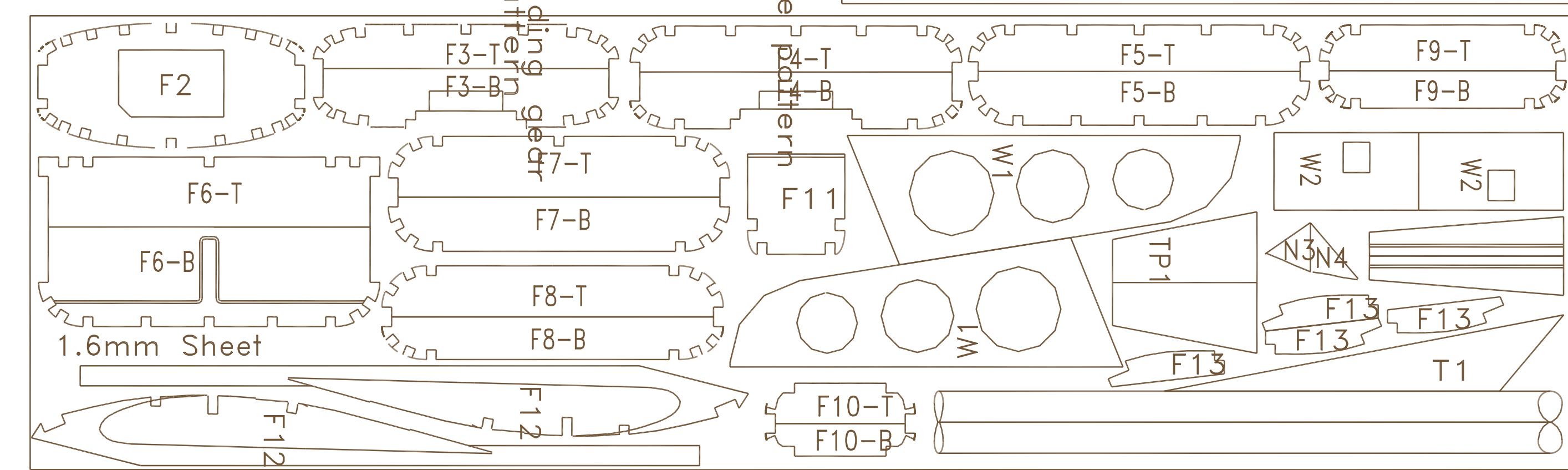

1.6mm Sheet

Inches
 Centimetres