

**Focke-Wulf Fw-159V3**  
 DRAWN BY: PRES BRUNING  
 SCALE: 3/16" = 1'-0"  
 REF: WINGPLANES OF THE 3RD RECH BY W.M. GREEN (P.179-81)  
 WINGSPAN - 23"

\* COLOR SCHEME: OVERALL LIGHT GREY EXCEPT WHERE OTHERWISE INDICATED.

RED BAND

ELEVATOR BALANCE PLATES

2-REQD FROM

1/32" SHEET

BALSA

BLACK LETTERING

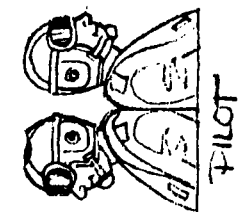

SCALE

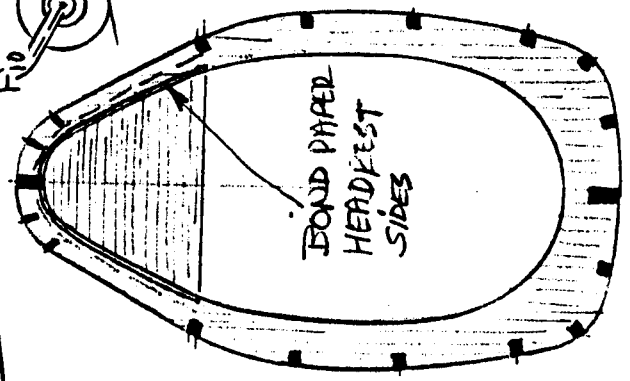
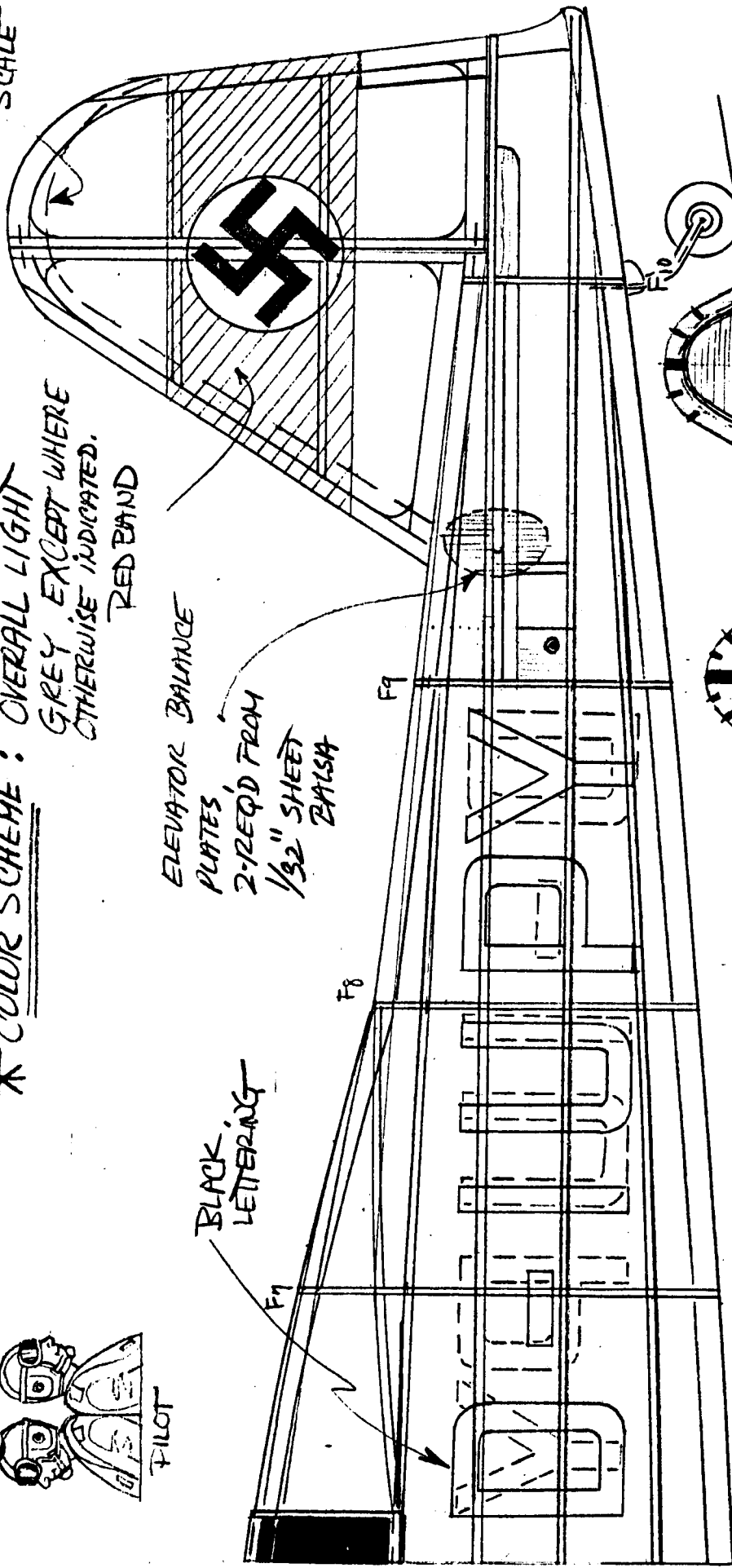

F6

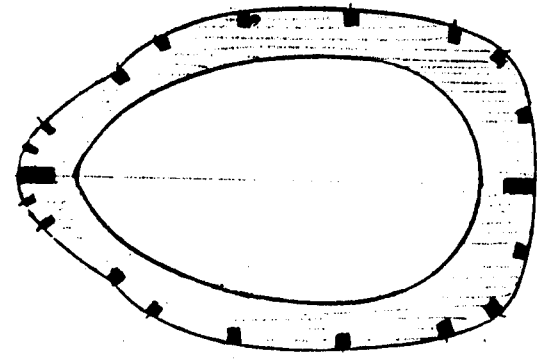

F7

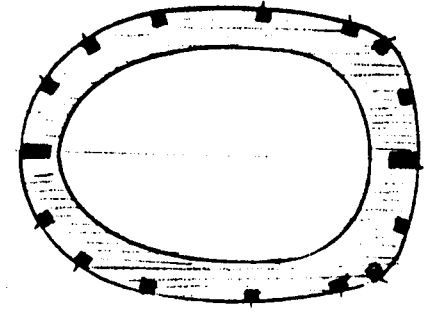

F8

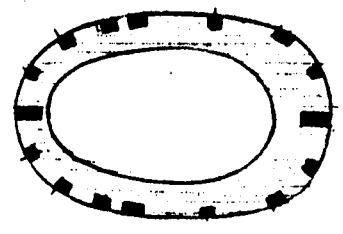

F9

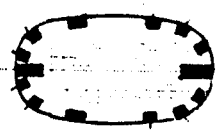

F10

BOND PAPER HEADREST SIDES

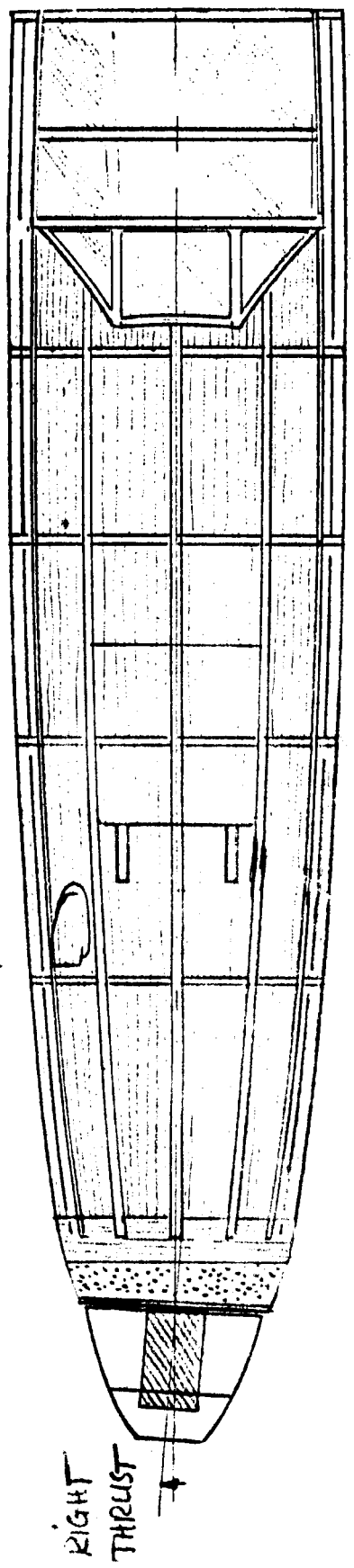
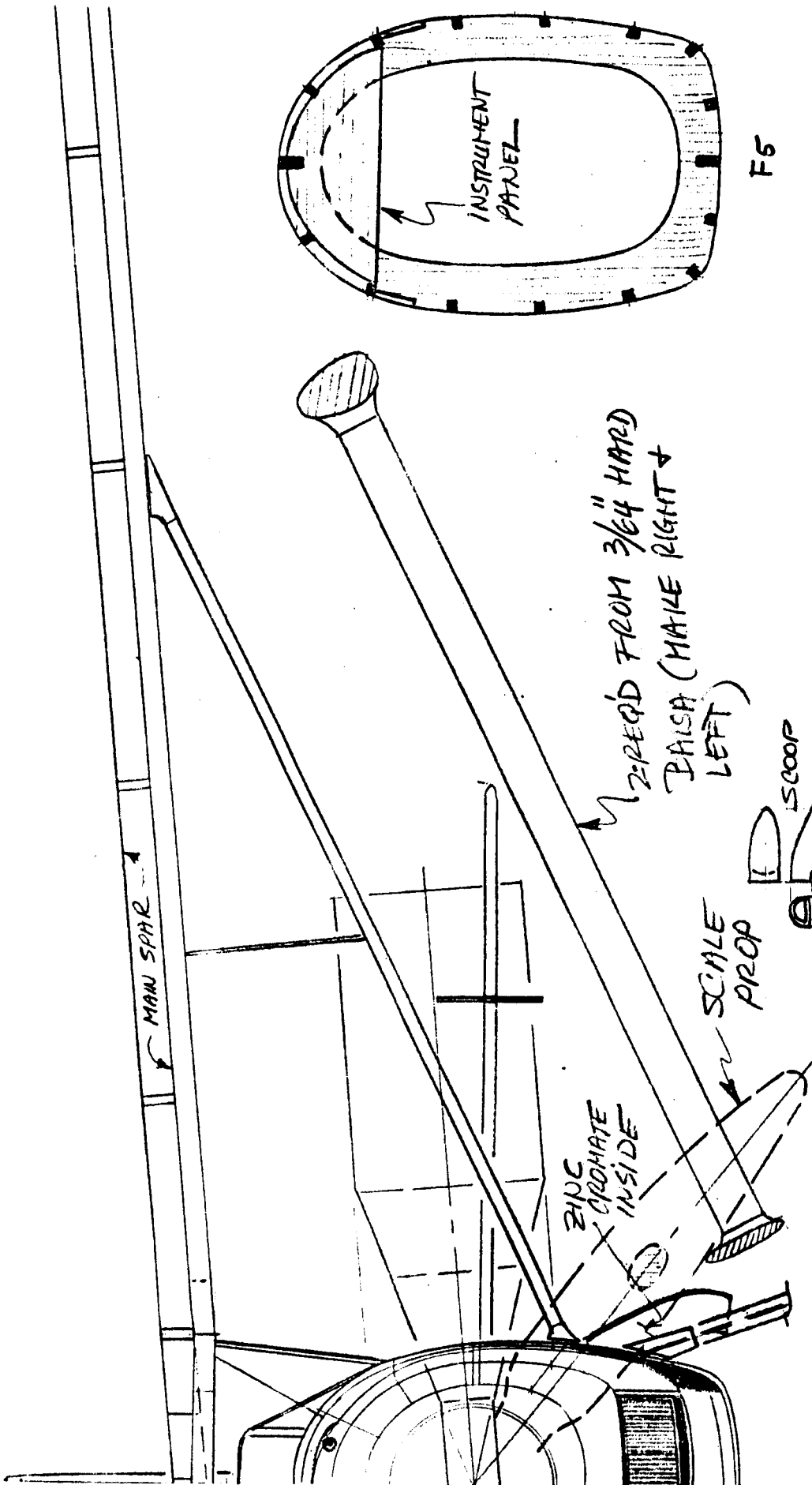

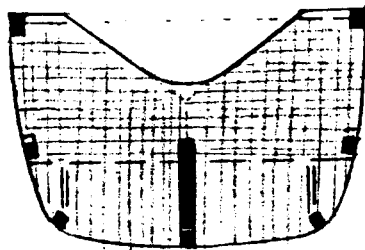
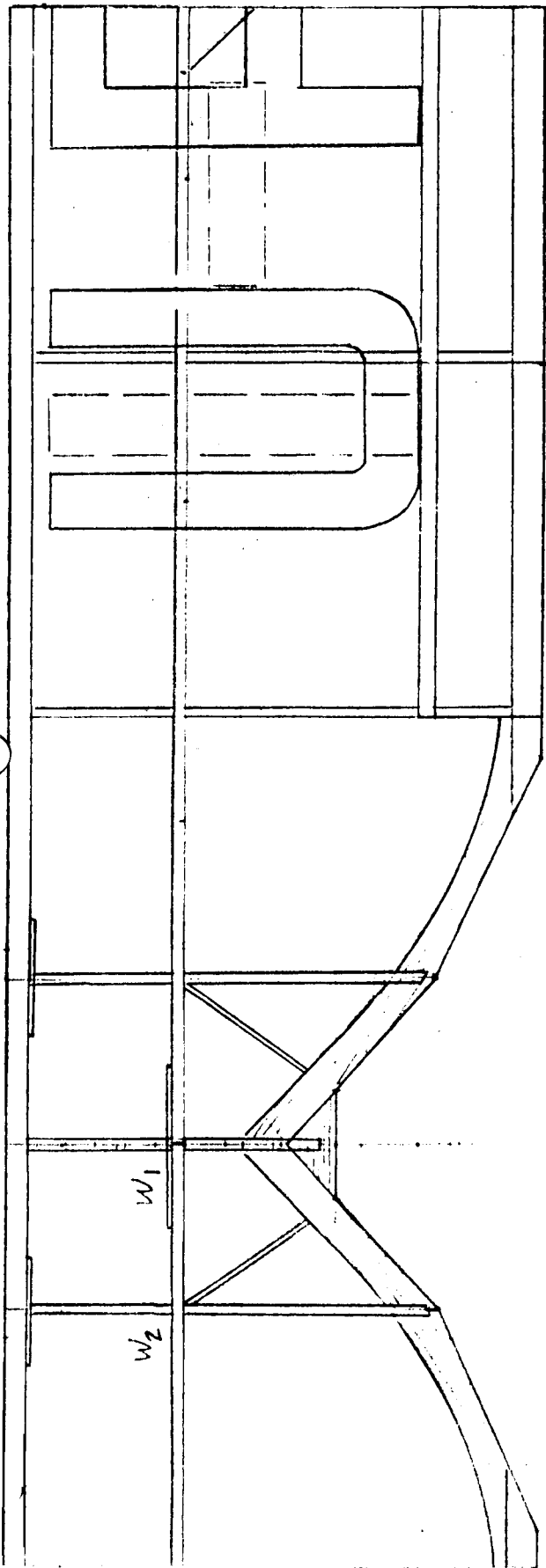

F 3A

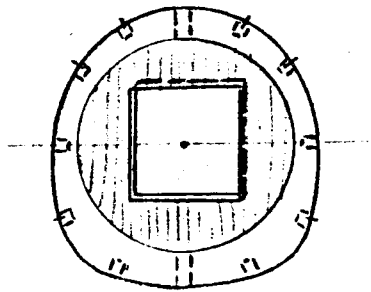

F<sub>1</sub>

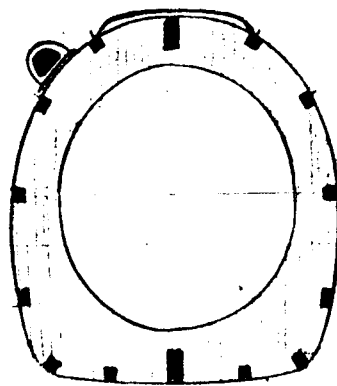

F<sub>2</sub>

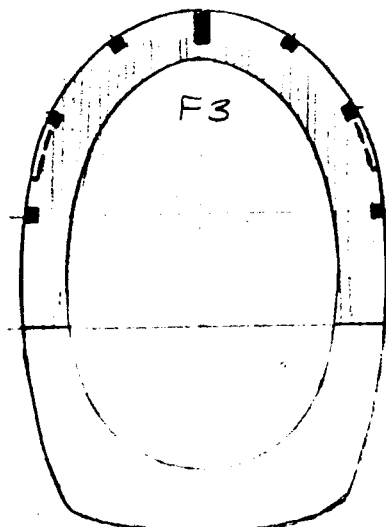

F<sub>3</sub>

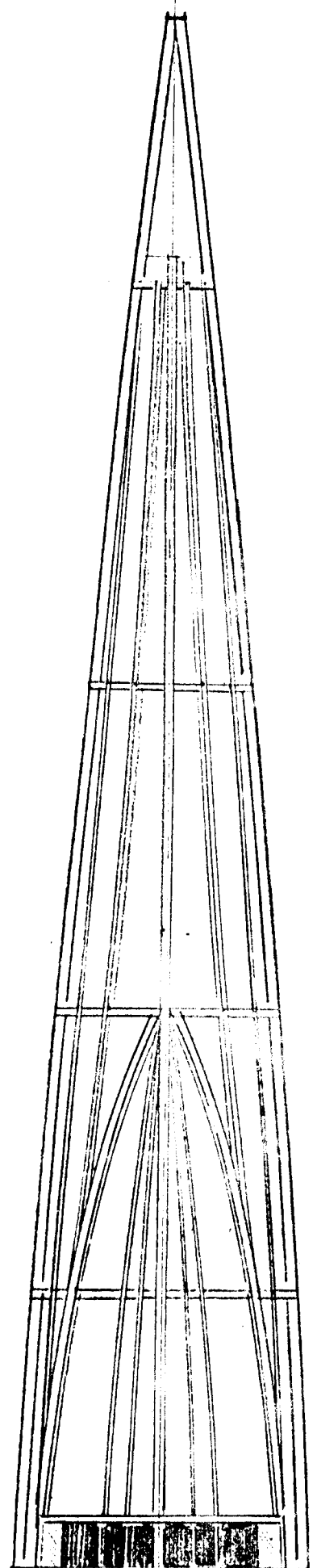

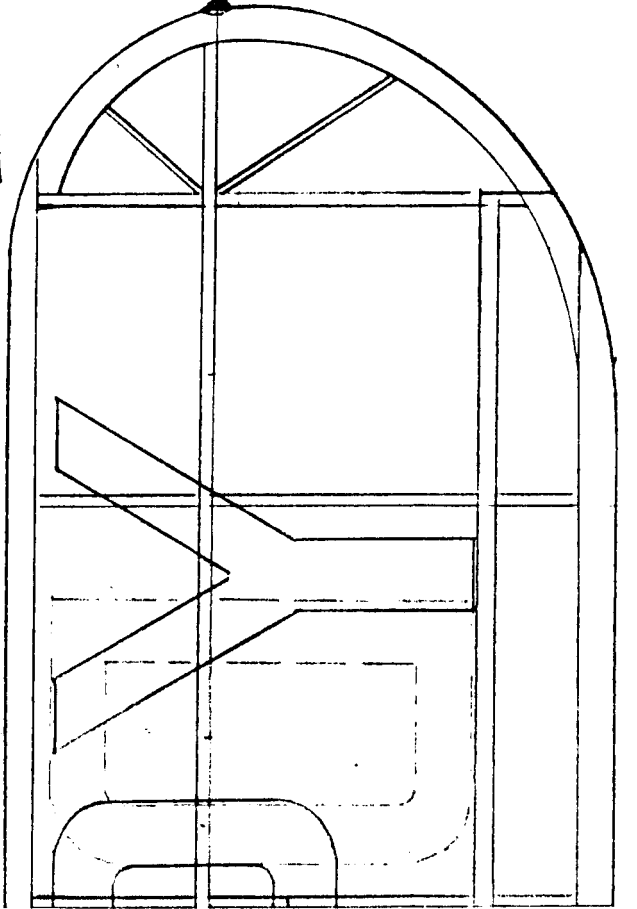
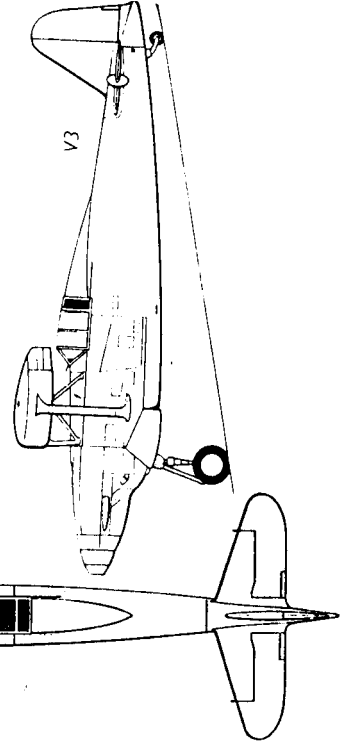
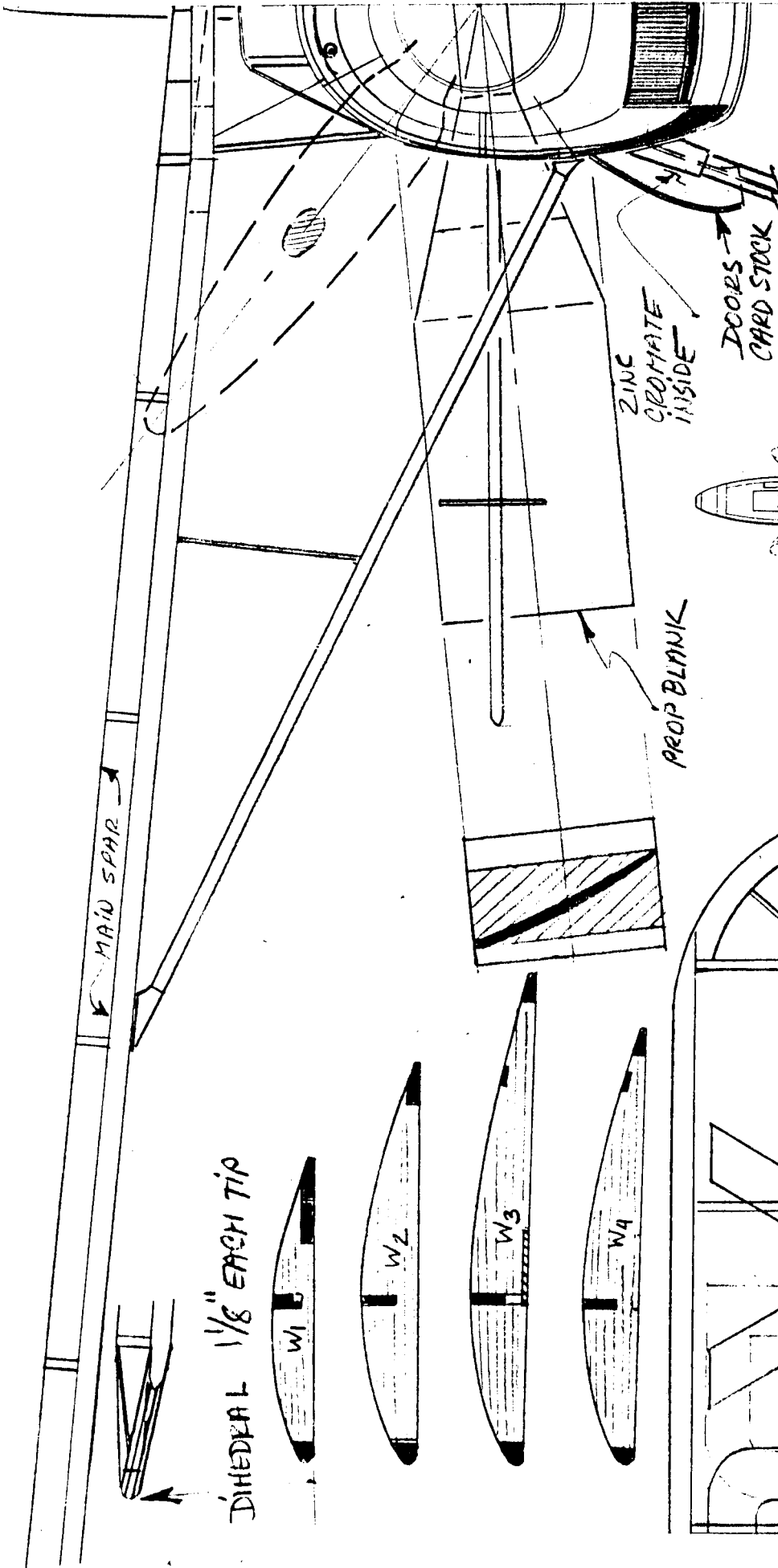

DIHEDRAL 1/8" EACH TIP

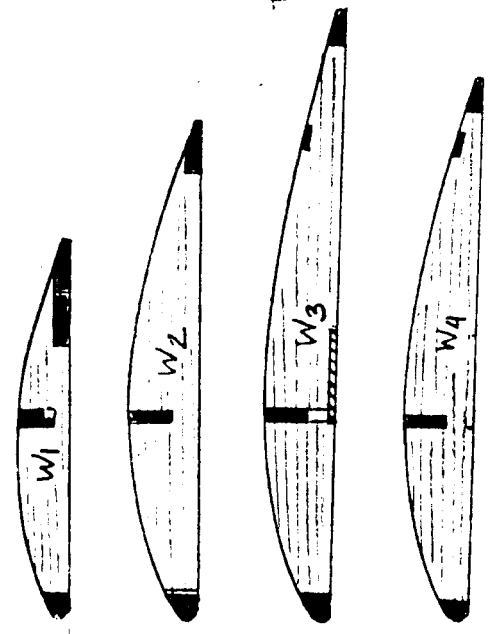

BLACK LETTERING

