

*Handwritten signature*

**ZERO**

DESIGNED BY J.K. GRIFFIN

SPAN LENGTH SCALE 26.75"  
20.625"  
APP. 1/16" = 1"

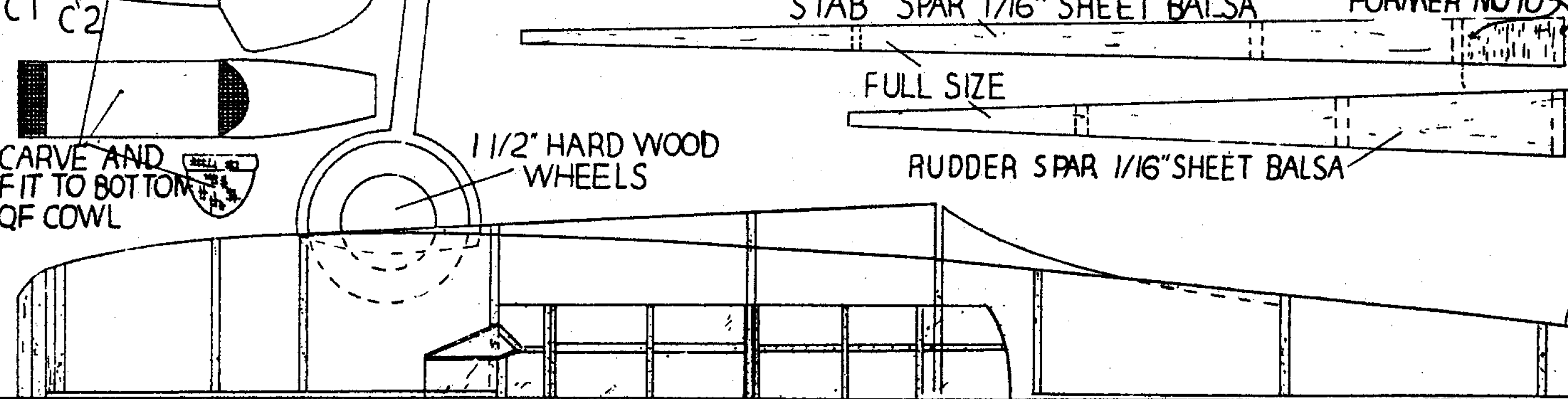
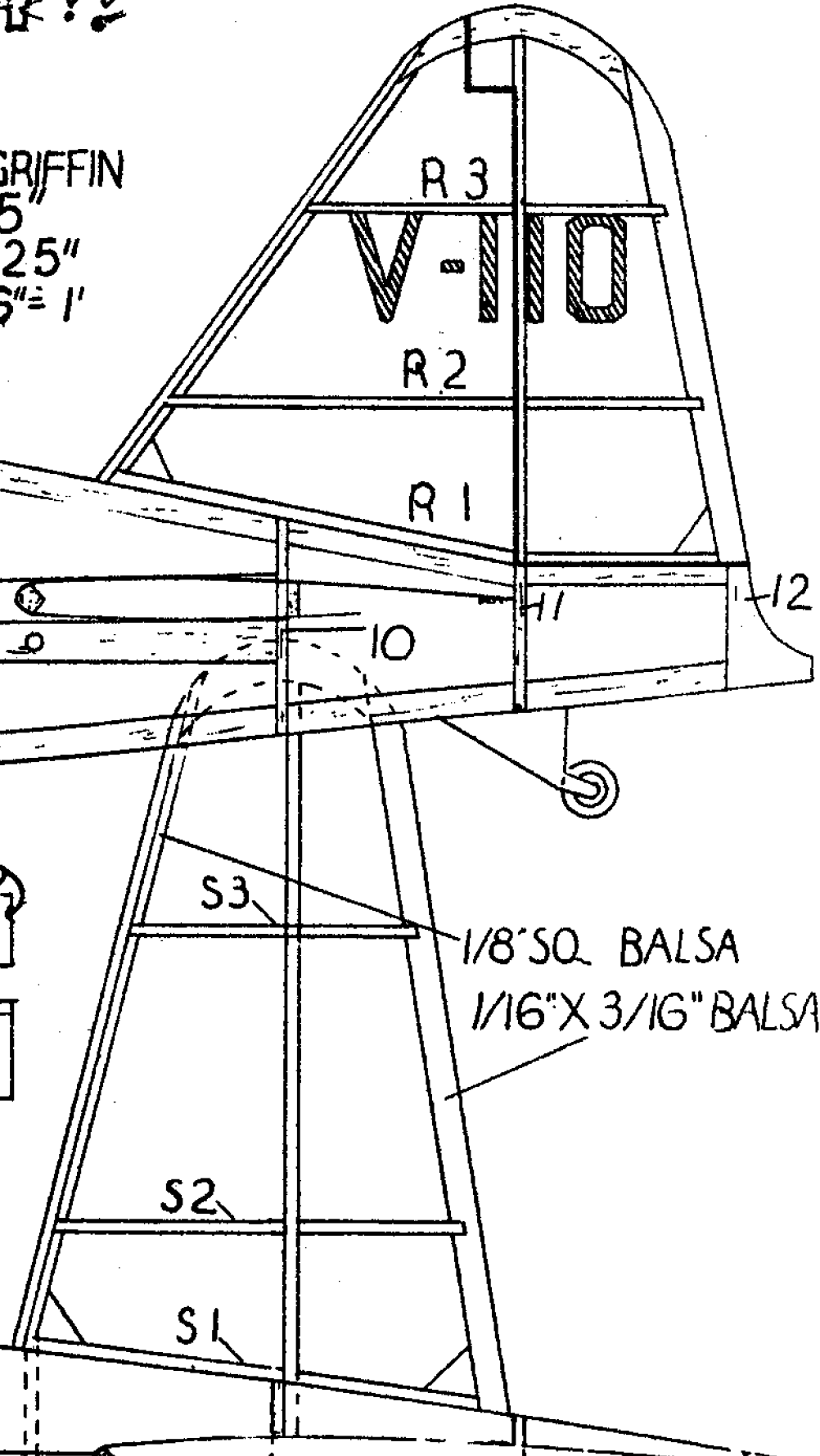
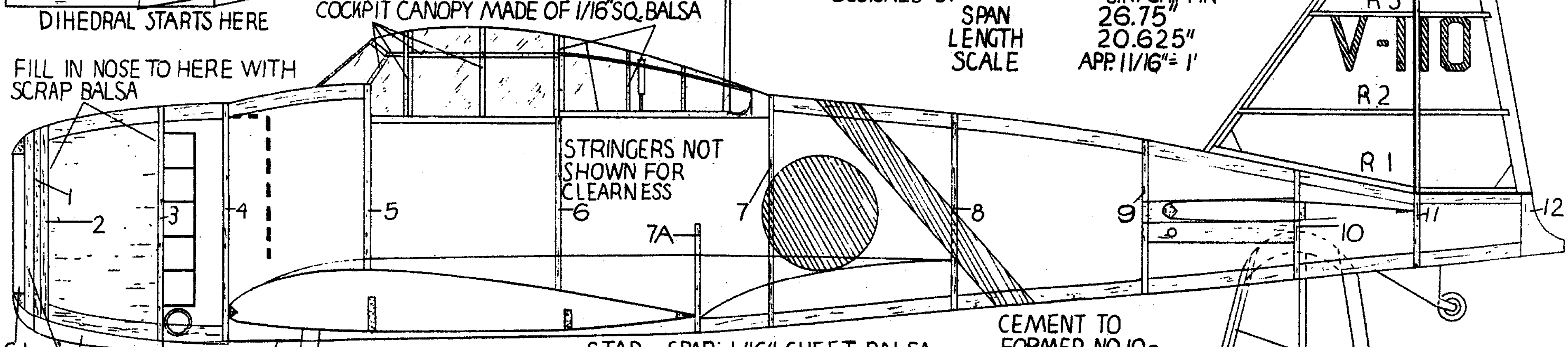

CARVE AND FIT TO BOTTOM OF COWL

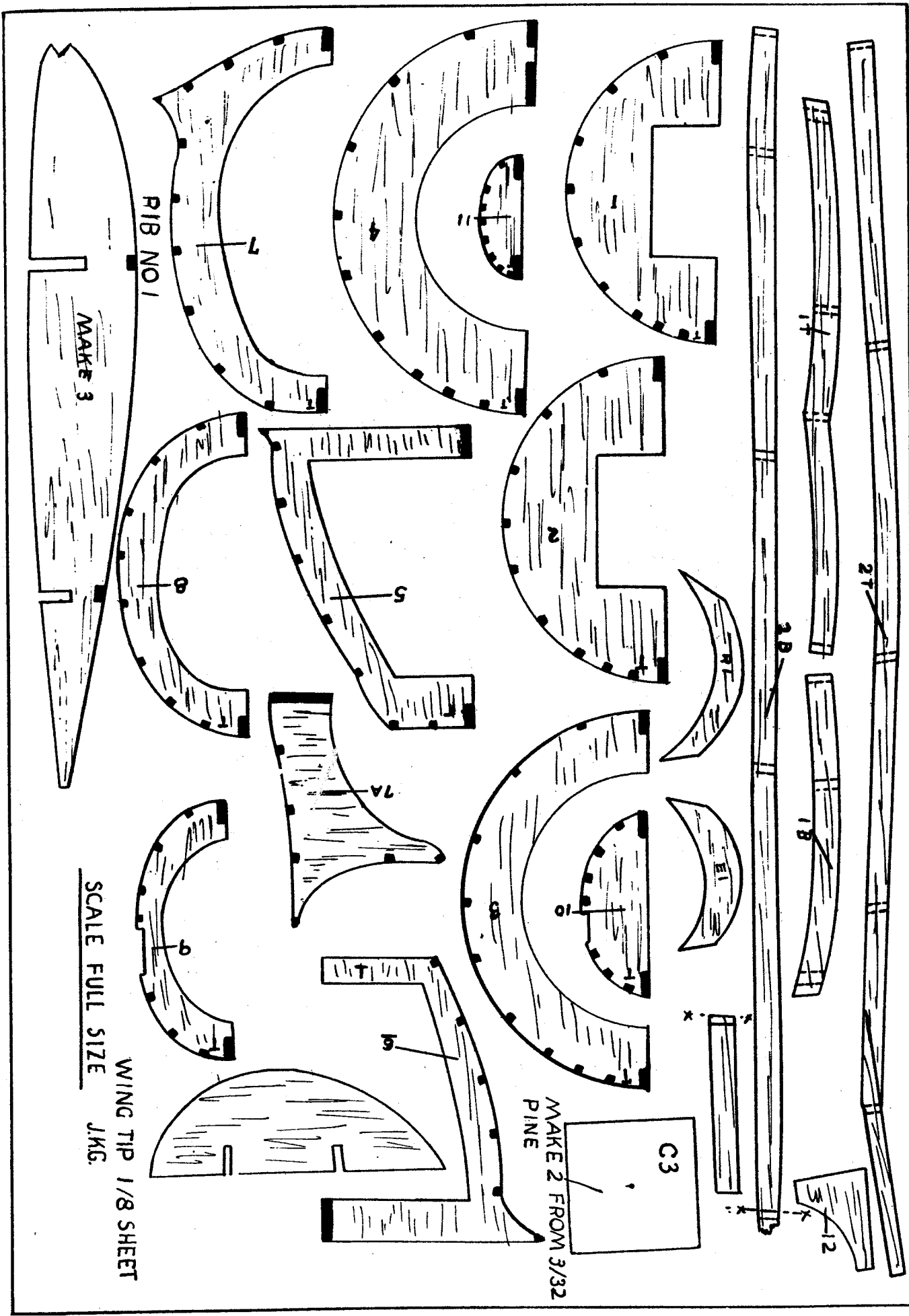

RIB NO 1

MAKE 3

SCALE FULL SIZE

WING TIP 1/8 SHEET

J.K.G.

MAKE 2 FROM 3/32 PINE

C3

7

8

9

4

5

15

7A

10

27

18

12

28

X

Y

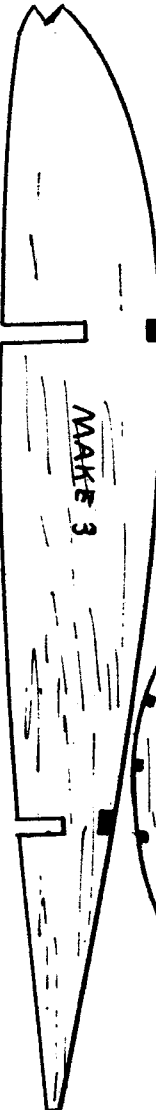
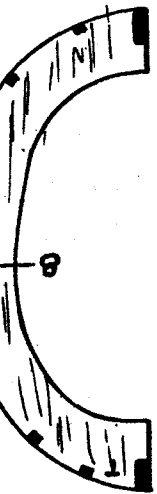
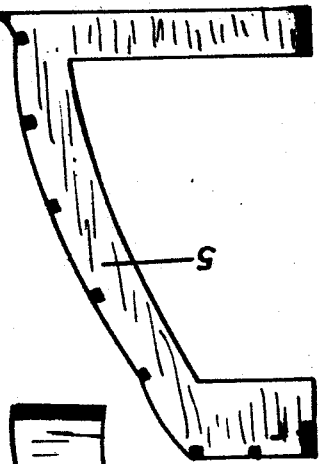
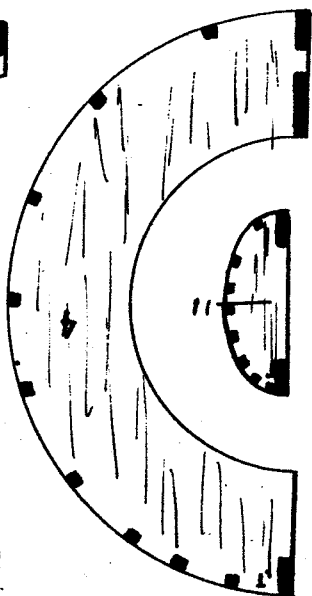
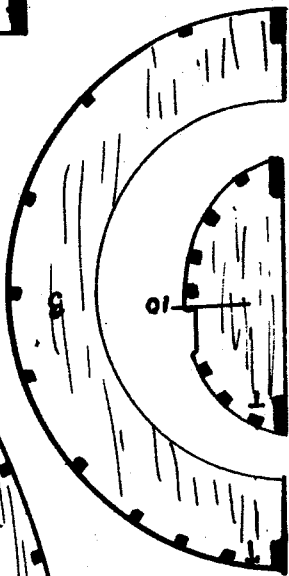
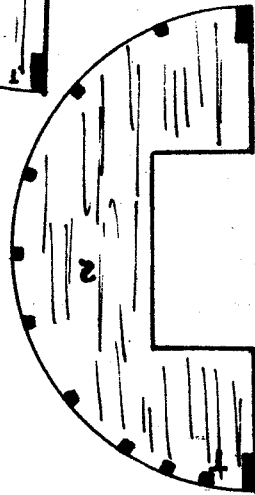
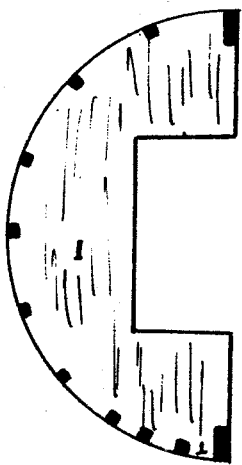

FRONT VIEW



ALL RIBS 1/16 SHEET BALSA

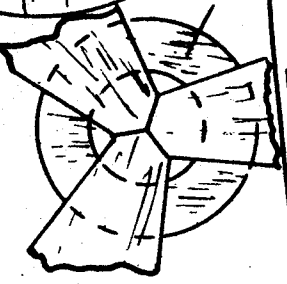
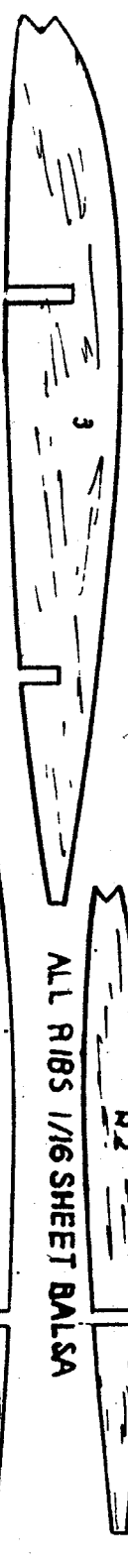

TAIL SKID  
CUT FROM  
1/16 PINE

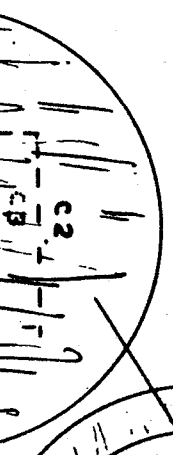

SPINNER 1X1X3/4"

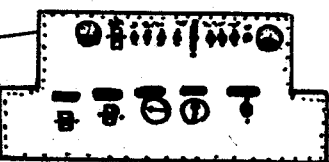
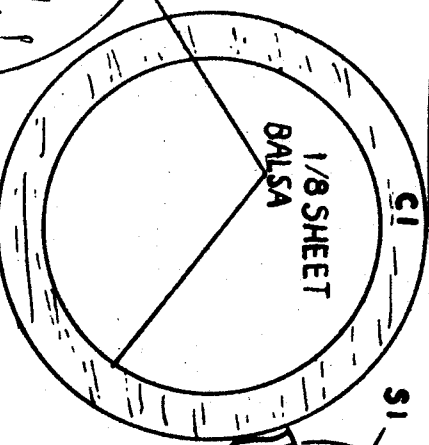

INSTRUMENT PANEL

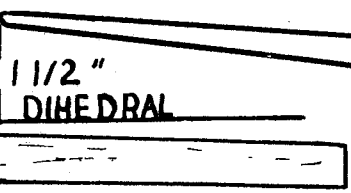

WHEEL COVER 1/32 BALSA

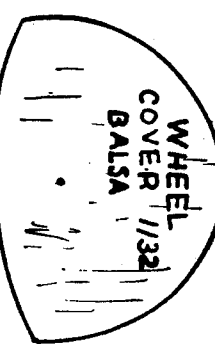

.049 STEEL WIRE

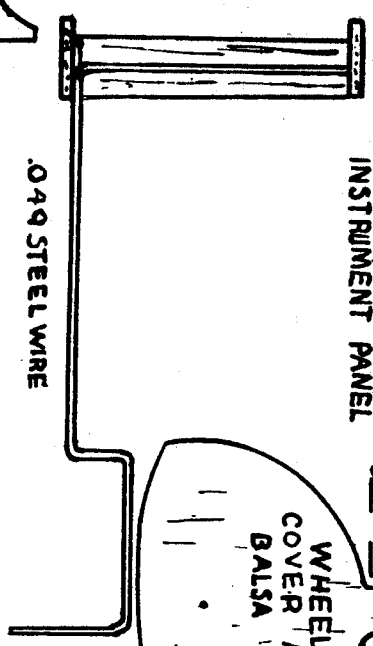

SCALE FULL SIZE J.K.G.

WING MOUNT  
1/8 BALSA

